

# Cree® XLamp® XHP35 LEDs

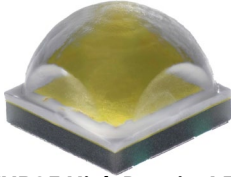

**XHP35 High Density LED**

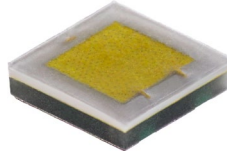

**XHP35 High Intensity LED**

## PRODUCT DESCRIPTION

The XLamp® XHP35 LED brings the performance of Cree’s Extreme High Power LEDs to the XP footprint, setting a new standard for performance delivered by a 3.45 x 3.45 mm LED. Leveraging the breakthrough 12-V monolithic power die built on Cree’s innovative architecture and uniquely enabled by the SC5 Technology™ Platform, the XHP35 LED allows the use of readily available cost-optimized drivers to unleash the capabilities of Cree’s high-power LEDs. Available in both high-density and high-intensity versions, the XHP35 LED is application optimized to enable new designs and radically lower system costs.

## FEATURES

- Available in white in high-density and high-intensity versions for design flexibility
- XHP35 High Intensity LED is optimized to deliver maximum candela through secondary optics
- Available in 5-step EasyWhite® bins at 2700 K to 5700 K CCT and 3-step EasyWhite bins at 2700 K to 3500 K CCT
- Available in ANSI white bins at 2700 K to 7000 K CCT
- Available in standard, 70-, 80-, 85- and 90-minimum CRI options
- Binned at 85 °C
- Maximum drive current: 1050 mA
- Low thermal resistance: 1.8 °C/W
- Wide viewing angle: 115° for high intensity, 125° for high density
- Unlimited floor life at ≤ 30 °C/85% RH
- Reflow solderable - JEDEC J-STD-020C
- RoHS and REACH compliant
- UL® recognized component (E349212)



## TABLE OF CONTENTS

|  |    |
|--|----|
| Characteristics .....                      | 2  |
| Flux Characteristics, High Density         |    |
| EasyWhite® Order Codes and Bins.....       | 3  |
| Flux Characteristics, High Density ANSI    |    |
| White Order Codes and Bins .....           | 5  |
| Flux Characteristics, High Intensity       |    |
| EasyWhite® Order Codes and Bins.....       | 8  |
| Flux Characteristics, High Intensity ANSI  |    |
| White Order Codes and Bins .....           | 11 |
| Relative Spectral Power Distribution ..... | 15 |
| Relative Flux vs. Junction Temperature.... | 15 |
| Electrical Characteristics.....            | 16 |
| Relative Flux vs. Current .....            | 16 |
| Relative Chromaticity vs. Current.....     | 17 |
| Relative Chromaticity vs. Temperature....  | 18 |
| Typical Spatial Distribution.....          | 19 |
| Thermal Design.....                        | 20 |
| Performance Groups – Luminous Flux.....    | 20 |
| Performance Groups – Chromaticity.....     | 21 |
| Cree’s EasyWhite® Chromaticity Regions     |    |
| Plotted on the 1931 CIE Curve .....        | 24 |
| Cree’s Standard Cool White Kits Plotted    |    |
| on ANSI Standard Chromaticity Regions..    | 27 |
| Cree’s Standard Warm and Neutral White     |    |
| Kits Plotted on ANSI Standard              |    |
| Chromaticity Regions .....                 | 28 |
| Bin and Order Code Formats.....            | 29 |
| Reflow Soldering Characteristics.....      | 30 |
| Notes .....                                | 31 |
| Mechanical Dimensions .....                | 33 |
| Tape and Reel.....                         | 35 |
| Packaging.....                             | 37 |

## CHARACTERISTICS

| Characteristics                              | Unit    | Minimum | Typical | Maximum |
|--|---------|---------|---------|---------|
| Thermal resistance, junction to solder point | °C/W    |         | 1.8     |         |
| Viewing angle (FWHM) - High Density          | degrees |         | 125     |         |
| Viewing angle (FWHM) - High Intensity        | degrees |         | 115     |         |
| Temperature coefficient of voltage           | mV/°C   |         | -8      |         |
| ESD withstand voltage (HBM per Mil-Std-883D) | V       |         |         | 8000    |
| DC forward current                           | mA      |         |         | 1050    |
| Reverse voltage                              | V       |         |         | -5      |
| Forward voltage (@ 350 mA, 85 °C)            | V       |         | 11.3    | 11.9    |
| LED junction temperature                     | °C      |         |         | 150     |

**FLUX CHARACTERISTICS, HIGH DENSITY EASYWHITE® ORDER CODES AND BINS ( $T_j = 85\text{ }^\circ\text{C}$ )**

The following table provides order codes for XLamp XHP35 High Density LEDs. For a complete description of how the flux and chromaticity groups are reflected in the bin code and order code nomenclature, please see the Bin and Order Code Formats section (page 29).

| Nominal CCT | CRI    |     | Minimum Luminous Flux @350 mA |                   |                    | 3-Step                   |            | 5-Step |                          |
|-------------|--------|-----|-------------------------------|-------------------|--------------------|--------------------------|------------|--------|--------------------------|
|             | Min    | Typ | Group                         | Flux (lm) @ 85 °C | Flux (lm) @ 25 °C* | Group                    | Order Code | Group  | Order Code               |
| 5700 K      | 70     |     | E4                            | 635               | 706                |                          |            | 57E    | XHP35A-00-0000-0D0BE457E |
|             |        |     | E2                            | 590               | 656                |                          |            |        | XHP35A-00-0000-0D0BE257E |
|             |        |     | D4                            | 550               | 612                |                          |            |        | XHP35A-00-0000-0D0BD457E |
|             | 80     |     | D4                            | 550               | 612                |                          |            | 57E    | XHP35A-00-0000-0D0HD457E |
|             |        |     | D2                            | 510               | 567                |                          |            |        | XHP35A-00-0000-0D0HD257E |
|             | 90     |     | C4                            | 475               | 528                |                          |            | 57E    | XHP35A-00-0000-0D0UC457E |
|             |        |     | C2                            | 440               | 489                |                          |            |        | XHP35A-00-0000-0D0UC257E |
|             |        |     | B4                            | 410               | 456                |                          |            |        | XHP35A-00-0000-0D0UB457E |
|             | 5000 K | 70  |                               | E4                | 635                | 706                      |            |        | 50E                      |
| E2          |        |     |                               | 590               | 656                | XHP35A-00-0000-0D0BE250E |            |        |                          |
| D4          |        |     |                               | 550               | 612                | XHP35A-00-0000-0D0BD450E |            |        |                          |
| 80          |        |     | D4                            | 550               | 612                |                          |            | 50E    | XHP35A-00-0000-0D0HD450E |
|             |        |     | D2                            | 510               | 567                |                          |            |        | XHP35A-00-0000-0D0HD250E |
| 90          |        |     | C4                            | 475               | 528                |                          |            | 50E    | XHP35A-00-0000-0D0UC450E |
|             |        |     | C2                            | 440               | 489                |                          |            |        | XHP35A-00-0000-0D0UC250E |
|             |        |     | B4                            | 410               | 456                |                          |            |        | XHP35A-00-0000-0D0UB450E |
| 4500 K      |        | 70  |                               | E2                | 590                | 656                      |            |        | 45E                      |
|             | D4     |     |                               | 550               | 612                | XHP35A-00-0000-0D0BD445E |            |        |                          |
|             | 80     |     | D4                            | 550               | 612                |                          |            | 45E    | XHP35A-00-0000-0D0HD445E |
|             |        |     | D2                            | 510               | 567                |                          |            |        | XHP35A-00-0000-0D0HD245E |
|             | 90     |     | C2                            | 440               | 489                |                          |            | 45E    | XHP35A-00-0000-0D0UC245E |
|             |        |     | B4                            | 410               | 456                |                          |            |        | XHP35A-00-0000-0D0UB445E |

**Notes:**

- Cree maintains a tolerance of  $\pm 7\%$  on flux and power measurements,  $\pm 0.005$  on chromaticity (CCx, CCy) measurements and  $\pm 2$  on CRI measurements. See the Measurements section (page 31).
- Cree XLamp XHP35 LED order codes specify only a minimum flux bin and not a maximum. Cree may ship reels in flux bins higher than the minimum specified by the order code without advance notice. Shipments will always adhere to the chromaticity bin restrictions specified by the order code.
- \* Flux values @ 25 °C are calculated and are for reference only.

**FLUX CHARACTERISTICS, HIGH DENSITY EASYWHITE® ORDER CODES AND BINS (T<sub>J</sub> = 85 °C) - CONTINUED**

| Nominal CCT | CRI |     | Minimum Luminous Flux @350 mA |                   |                    | 3-Step                   |                          | 5-Step                   |                          |
|-------------|-----|-----|-------------------------------|-------------------|--------------------|--------------------------|--------------------------|--------------------------|--------------------------|
|             | Min | Typ | Group                         | Flux (lm) @ 85 °C | Flux (lm) @ 25 °C* | Group                    | Order Code               | Group                    | Order Code               |
| 4000 K      | 70  |     | E2                            | 590               | 656                |                          |                          | 40E                      | XHP35A-00-0000-0D0BE240E |
|             |     |     | D4                            | 550               | 612                |                          |                          |                          | XHP35A-00-0000-0D0BD440E |
|             |     |     | D2                            | 510               | 567                |                          |                          |                          | XHP35A-00-0000-0D0BD240E |
|             | 80  |     | D4                            | 550               | 612                |                          |                          | 40E                      | XHP35A-00-0000-0D0HD440E |
|             |     |     | D2                            | 510               | 567                |                          |                          |                          | XHP35A-00-0000-0D0HD240E |
|             | 90  |     | C2                            | 440               | 489                |                          |                          | 40E                      | XHP35A-00-0000-0D0UC240E |
| B4          |     |     | 410                           | 456               |                    |                          | XHP35A-00-0000-0D0UB440E |                          |                          |
| 3500 K      | 70  |     | E2                            | 590               | 656                |                          |                          | 35E                      | XHP35A-00-0000-0D0BE235E |
|             |     |     | D4                            | 550               | 612                |                          |                          |                          | XHP35A-00-0000-0D0BD435E |
|             |     |     | D2                            | 510               | 567                |                          |                          |                          | XHP35A-00-0000-0D0BD235E |
|             | 80  |     | D4                            | 550               | 612                | 35G                      | XHP35A-00-0000-0D0HD435G | 35E                      | XHP35A-00-0000-0D0HD435E |
|             |     |     | D2                            | 510               | 567                |                          | XHP35A-00-0000-0D0HD235G |                          | XHP35A-00-0000-0D0HD235E |
|             |     |     | C4                            | 475               | 528                |                          | XHP35A-00-0000-0D0HC435G |                          | XHP35A-00-0000-0D0HC435E |
| 90          |     | C2  | 440                           | 489               | 35G                | XHP35A-00-0000-0D0UC235G | 35E                      | XHP35A-00-0000-0D0UC235E |                          |
|             |     | B4  | 410                           | 456               |                    | XHP35A-00-0000-0D0UB435G |                          | XHP35A-00-0000-0D0UB435E |                          |
| 3000 K      | 70  |     | D4                            | 550               | 612                |                          |                          | 30E                      | XHP35A-00-0000-0D0BD430E |
|             |     |     | D2                            | 510               | 567                |                          |                          |                          | XHP35A-00-0000-0D0BD230E |
|             | 80  |     | D2                            | 510               | 567                | 30G                      | XHP35A-00-0000-0D0HD230G | 30E                      | XHP35A-00-0000-0D0HD230E |
|             |     |     | C4                            | 475               | 528                |                          | XHP35A-00-0000-0D0HC430G |                          | XHP35A-00-0000-0D0HC430E |
|             | 90  |     | C2                            | 440               | 489                | 30G                      | XHP35A-00-0000-0D0UC230G | 30E                      | XHP35A-00-0000-0D0UC230E |
|             |     |     | B4                            | 410               | 456                |                          | XHP35A-00-0000-0D0UB430G |                          | XHP35A-00-0000-0D0UB430E |
|             |     | B2  | 380                           | 423               |                    | XHP35A-00-0000-0D0UB230G |                          | XHP35A-00-0000-0D0UB230E |                          |
| 2700 K      | 80  |     | C4                            | 475               | 528                | 27G                      | XHP35A-00-0000-0D0HC427G | 27E                      | XHP35A-00-0000-0D0HC427E |
|             |     |     | C2                            | 440               | 489                |                          | XHP35A-00-0000-0D0HC227G |                          | XHP35A-00-0000-0D0HC227E |
|             | 90  |     | B4                            | 410               | 456                | 27G                      | XHP35A-00-0000-0D0UB427G | 27E                      | XHP35A-00-0000-0D0UB427E |
|             |     |     | B2                            | 380               | 423                |                          | XHP35A-00-0000-0D0UB227G |                          | XHP35A-00-0000-0D0UB227E |

**Notes:**

- Cree maintains a tolerance of ±7% on flux and power measurements, ±0.005 on chromaticity (CC<sub>x</sub>, CC<sub>y</sub>) measurements and ±2 on CRI measurements. See the Measurements section (page 31).
- Cree XLamp XHP35 LED order codes specify only a minimum flux bin and not a maximum. Cree may ship reels in flux bins higher than the minimum specified by the order code without advance notice. Shipments will always adhere to the chromaticity bin restrictions specified by the order code.
- \* Flux values @ 25 °C are calculated and are for reference only.

**FLUX CHARACTERISTICS, HIGH DENSITY ANSI WHITE ORDER CODES AND BINS (T<sub>j</sub> = 85 °C)**

The following table provides order codes for XLamp XHP35 High Density LEDs. For a complete description of how the flux and chromaticity groups are reflected in the bin code and order code nomenclature, please see the Bin and Order Code Formats section (page 29).

| Nominal CCT | Chromaticity Regions   | CRI    |                | Minimum Luminous Flux @ 350 mA |                   |                    | Order Code               |     |                          |
|-------------|--|--------|----------------|--------------------------------|-------------------|--------------------|--------------------------|-----|--------------------------|
|             |  | Min    | Typ            | Group                          | Flux (lm) @ 85 °C | Flux (lm) @ 25 °C* |                          |     |                          |
| 7000 K      | 0A, 0B, 0C, 0D, 0R, 0S, 0T, 0U, 1A, 1B, 1C, 1D, 1R, 1S, 1T, 1U | 0      | 68             | E4                             | 635               | 706                | XHP35A-00-0000-0D00E40DT |     |                          |
|             |  |        |                | E2                             | 590               | 656                | XHP35A-00-0000-0D00E20DT |     |                          |
|             |  |        |                | D4                             | 550               | 612                | XHP35A-00-0000-0D00D40DT |     |                          |
|             |  | 70     |                |                                |                   | E4                 | 635                      | 706 | XHP35A-00-0000-0D0BE40DT |
|             |  |        |                |                                |                   | E2                 | 590                      | 656 | XHP35A-00-0000-0D0BE20DT |
|             |  |        |                |                                |                   | D4                 | 550                      | 612 | XHP35A-00-0000-0D0BD40DT |
|             |  | 80     |                |                                |                   | D4                 | 550                      | 612 | XHP35A-00-0000-0D0HD40DT |
|             |  |        |                |                                |                   | D2                 | 510                      | 567 | XHP35A-00-0000-0D0HD20DT |
|             |  | 90     |                |                                |                   | C4                 | 475                      | 528 | XHP35A-00-0000-0D0UC40DT |
|             |  |        |                |                                |                   | C2                 | 440                      | 489 | XHP35A-00-0000-0D0UC20DT |
|             |  |        |                |                                |                   | B4                 | 410                      | 456 | XHP35A-00-0000-0D0UB40DT |
|             |  | 6500 K | 1A, 1B, 1C, 1D | 0                              | 68                | E4                 | 635                      | 706 | XHP35A-00-0000-0D00E40E1 |
| E2          | 590  |        |                |                                |                   | 656                | XHP35A-00-0000-0D00E20E1 |     |                          |
| D4          | 550  |        |                |                                |                   | 612                | XHP35A-00-0000-0D00D40E1 |     |                          |
| 70          |  |        |                |                                |                   | E4                 | 635                      | 706 | XHP35A-00-0000-0D0BE40E1 |
|             |  |        |                |                                |                   | E2                 | 590                      | 656 | XHP35A-00-0000-0D0BE20E1 |
|             |  |        |                |                                |                   | D4                 | 550                      | 612 | XHP35A-00-0000-0D0BD40E1 |
| 80          |  |        |                |                                |                   | D4                 | 550                      | 612 | XHP35A-00-0000-0D0HD40E1 |
|             |  |        |                |                                |                   | D2                 | 510                      | 567 | XHP35A-00-0000-0D0HD20E1 |
| 90          |  |        |                |                                |                   | C4                 | 475                      | 528 | XHP35A-00-0000-0D0UC40E1 |
|             |  |        |                |                                |                   | C2                 | 440                      | 489 | XHP35A-00-0000-0D0UC20E1 |
|             |  |        |                |                                |                   | B4                 | 410                      | 456 | XHP35A-00-0000-0D0UB40E1 |
| 6000 K      | 1A, 1B, 1C, 1D, 1R, 1S, 1T, 1U, 2A, 2B, 2C, 2D, 2R, 2S, 2T, 2U |        |                | 0                              | 68                | E4                 | 635                      | 706 | XHP35A-00-0000-0D00E40DV |
|             |  | E2     | 590            |                                |                   | 656                | XHP35A-00-0000-0D00E20DV |     |                          |
|             |  | D4     | 550            |                                |                   | 612                | XHP35A-00-0000-0D00D40DV |     |                          |
|             |  | 70     |                |                                |                   | E4                 | 635                      | 706 | XHP35A-00-0000-0D0BE40DV |
|             |  |        |                |                                |                   | E2                 | 590                      | 656 | XHP35A-00-0000-0D0BE20DV |
|             |  |        |                |                                |                   | D4                 | 550                      | 612 | XHP35A-00-0000-0D0BD40DV |
|             |  | 80     |                |                                |                   | D4                 | 550                      | 612 | XHP35A-00-0000-0D0HD40DV |
|             |  |        |                |                                |                   | D2                 | 510                      | 567 | XHP35A-00-0000-0D0HD20DV |
|             |  | 90     |                |                                |                   | C4                 | 475                      | 528 | XHP35A-00-0000-0D0UC40DV |
|             |  |        |                |                                |                   | C2                 | 440                      | 489 | XHP35A-00-0000-0D0UC20DV |
|             |  |        |                |                                |                   | B4                 | 410                      | 456 | XHP35A-00-0000-0D0UB40DV |

- Notes:
- Cree maintains a tolerance of ±7% on flux and power measurements, ±0.005 on chromaticity (CCx, CCy) measurements and ±2 on CRI measurements. See the Measurements section (page 31).
  - Cree XLamp XHP35 LED order codes specify only a minimum flux bin and not a maximum. Cree may ship reels in flux bins higher than the minimum specified by the order code without advance notice. Shipments will always adhere to the chromaticity bin restrictions specified by the order code.
  - \* Flux values @ 25 °C are calculated and are for reference only.

**FLUX CHARACTERISTICS, HIGH DENSITY ANSI ORDER CODES AND BINS ( $T_j = 85\text{ }^\circ\text{C}$ ) - CONTINUED**

| Nominal CCT | Chromaticity Regions | CRI    |                | Minimum Luminous Flux @ 350 mA |                   |                    | Order Code               |     |                           |
|-------------|----------------------|--------|----------------|--------------------------------|-------------------|--------------------|--------------------------|-----|---------------------------|
|             |                      | Min    | Typ            | Group                          | Flux (lm) @ 85 °C | Flux (lm) @ 25 °C* |                          |     |                           |
| 5700 K      | 2A, 2B, 2C, 2D       | 0      | 68             | E4                             | 635               | 706                | XHP35A-00-0000-0D00E40E2 |     |                           |
|             |                      |        |                | E2                             | 590               | 656                | XHP35A-00-0000-0D00E20E2 |     |                           |
|             |                      |        |                | D4                             | 550               | 612                | XHP35A-00-0000-0D00D40E2 |     |                           |
|             |                      | 70     |                |                                |                   | E4                 | 635                      | 706 | XHP35A-00-0000-0D00E40E2  |
|             |                      |        |                |                                |                   | E2                 | 590                      | 656 | XHP35A-00-0000-0D00E20E2  |
|             |                      |        |                |                                |                   | D4                 | 550                      | 612 | XHP35A-00-0000-0D00D40E2  |
|             |                      | 80     |                |                                |                   | D4                 | 550                      | 612 | XHP35A-00-0000-0D00HD40E2 |
|             |                      |        |                |                                |                   | D2                 | 510                      | 567 | XHP35A-00-0000-0D00HD20E2 |
|             |                      | 90     |                |                                |                   | C4                 | 475                      | 528 | XHP35A-00-0000-0D00UC40E2 |
|             |                      |        |                |                                |                   | C2                 | 440                      | 489 | XHP35A-00-0000-0D00UC20E2 |
|             |                      |        |                |                                |                   | B4                 | 410                      | 456 | XHP35A-00-0000-0D00UB40E2 |
|             |                      | 5000 K | 3A, 3B, 3C, 3D | 0                              | 68                | E4                 | 635                      | 706 | XHP35A-00-0000-0D00E40E3  |
| E2          | 590                  |        |                |                                |                   | 656                | XHP35A-00-0000-0D00E20E3 |     |                           |
| D4          | 550                  |        |                |                                |                   | 612                | XHP35A-00-0000-0D00D40E3 |     |                           |
| 70          |                      |        |                |                                |                   | E4                 | 635                      | 706 | XHP35A-00-0000-0D00E40E3  |
|             |                      |        |                |                                |                   | E2                 | 590                      | 656 | XHP35A-00-0000-0D00E20E3  |
|             |                      |        |                |                                |                   | D4                 | 550                      | 612 | XHP35A-00-0000-0D00D40E3  |
| 80          |                      |        |                |                                |                   | D4                 | 550                      | 612 | XHP35A-00-0000-0D00HD40E3 |
|             |                      |        |                |                                |                   | D2                 | 510                      | 567 | XHP35A-00-0000-0D00HD20E3 |
| 90          |                      |        |                |                                |                   | C4                 | 475                      | 528 | XHP35A-00-0000-0D00UC40E3 |
|             |                      |        |                |                                |                   | C2                 | 440                      | 489 | XHP35A-00-0000-0D00UC20E3 |
|             |                      |        |                |                                |                   | B4                 | 410                      | 456 | XHP35A-00-0000-0D00UB40E3 |
| 4500 K      | 4A, 4B, 4C, 4D       |        |                | 0                              | 68                | E2                 | 590                      | 656 | XHP35A-00-0000-0D00E20E4  |
|             |                      | D4     | 550            |                                |                   | 612                | XHP35A-00-0000-0D00D40E4 |     |                           |
|             |                      | 70     |                |                                |                   | E2                 | 590                      | 656 | XHP35A-00-0000-0D00E20E4  |
|             |                      |        |                |                                |                   | D4                 | 550                      | 612 | XHP35A-00-0000-0D00D40E4  |
|             |                      | 80     |                |                                |                   | D4                 | 550                      | 612 | XHP35A-00-0000-0D00HD40E4 |
|             |                      |        |                |                                |                   | D2                 | 510                      | 567 | XHP35A-00-0000-0D00HD20E4 |
|             |                      | 90     |                |                                |                   | C4                 | 475                      | 528 | XHP35A-00-0000-0D00UC40E4 |
|             |                      |        |                |                                |                   | C2                 | 440                      | 489 | XHP35A-00-0000-0D00UC20E4 |
|             |                      |        |                |                                |                   | B4                 | 410                      | 456 | XHP35A-00-0000-0D00UB40E4 |

**Notes:**

- Cree maintains a tolerance of  $\pm 7\%$  on flux and power measurements,  $\pm 0.005$  on chromaticity (CCx, CCy) measurements and  $\pm 2$  on CRI measurements. See the Measurements section (page 31).
- Cree XLamp XHP35 LED order codes specify only a minimum flux bin and not a maximum. Cree may ship reels in flux bins higher than the minimum specified by the order code without advance notice. Shipments will always adhere to the chromaticity bin restrictions specified by the order code.
- \* Flux values @ 25 °C are calculated and are for reference only.

**FLUX CHARACTERISTICS, HIGH DENSITY ANSI ORDER CODES AND BINS ( $T_j = 85^\circ\text{C}$ ) - CONTINUED**

| Nominal CCT | Chromaticity Regions | CRI    |                | Minimum Luminous Flux @ 350 mA |                   |                    | Order Code               |     |                           |                          |     |                           |                           |                           |
|-------------|----------------------|--------|----------------|--------------------------------|-------------------|--------------------|--------------------------|-----|---------------------------|--------------------------|-----|---------------------------|---------------------------|---------------------------|
|             |                      | Min    | Typ            | Group                          | Flux (lm) @ 85 °C | Flux (lm) @ 25 °C* |                          |     |                           |                          |     |                           |                           |                           |
| 4000 K      | 5A, 5B, 5C, 5D       | 0      | 68             | E2                             | 590               | 656                | XHP35A-00-0000-0D00E20E5 |     |                           |                          |     |                           |                           |                           |
|             |                      |        |                | D4                             | 550               | 612                | XHP35A-00-0000-0D00D40E5 |     |                           |                          |     |                           |                           |                           |
|             |                      |        |                | D2                             | 510               | 567                | XHP35A-00-0000-0D00D20E5 |     |                           |                          |     |                           |                           |                           |
|             |                      | 70     |                |                                |                   | E2                 | 590                      | 656 | XHP35A-00-0000-0D00E20E5  |                          |     |                           |                           |                           |
|             |                      |        |                |                                |                   | D4                 | 550                      | 612 | XHP35A-00-0000-0D00D40E5  |                          |     |                           |                           |                           |
|             |                      |        |                |                                |                   | D2                 | 510                      | 567 | XHP35A-00-0000-0D00D20E5  |                          |     |                           |                           |                           |
|             |                      | 80     |                |                                |                   | D4                 | 550                      | 612 | XHP35A-00-0000-0D00HD40E5 |                          |     |                           |                           |                           |
|             |                      |        |                |                                |                   | D2                 | 510                      | 567 | XHP35A-00-0000-0D00HD20E5 |                          |     |                           |                           |                           |
|             |                      | 90     |                |                                |                   | C2                 | 440                      | 489 | XHP35A-00-0000-0D00UC20E5 |                          |     |                           |                           |                           |
|             |                      |        |                |                                |                   | B4                 | 410                      | 456 | XHP35A-00-0000-0D00UB40E5 |                          |     |                           |                           |                           |
|             |                      | 3500 K | 6A, 6B, 6C, 6D | 70                             |                   |                    |                          |     | E2                        | 590                      | 656 | XHP35A-00-0000-0D00E20E6  |                           |                           |
|             |                      |        |                |                                |                   |                    |                          |     | D4                        | 550                      | 612 | XHP35A-00-0000-0D00D40E6  |                           |                           |
| D2          | 510                  |        |                |                                |                   |                    |                          |     | 567                       | XHP35A-00-0000-0D00D20E6 |     |                           |                           |                           |
| 80          |                      |        |                |                                |                   |                    |                          |     | D4                        | 550                      | 612 | XHP35A-00-0000-0D00HD40E6 |                           |                           |
|             |                      |        |                |                                |                   |                    |                          |     | D2                        | 510                      | 567 | XHP35A-00-0000-0D00HD20E6 |                           |                           |
|             |                      |        |                |                                |                   |                    |                          |     | C4                        | 475                      | 528 | XHP35A-00-0000-0D00HC40E6 |                           |                           |
| 90          |                      |        |                |                                |                   |                    |                          |     | C2                        | 440                      | 489 | XHP35A-00-0000-0D00UC20E6 |                           |                           |
|             |                      |        |                |                                |                   |                    |                          |     | B4                        | 410                      | 456 | XHP35A-00-0000-0D00UB40E6 |                           |                           |
| 3000 K      | 7A, 7B, 7C, 7D       |        |                | 70                             |                   |                    |                          |     |                           | D4                       | 550 | 612                       | XHP35A-00-0000-0D00D40E7  |                           |
|             |                      |        |                |                                |                   |                    |                          |     |                           | D2                       | 510 | 567                       | XHP35A-00-0000-0D00D20E7  |                           |
|             |                      |        |                | 80                             |                   |                    |                          |     |                           |                          | D2  | 510                       | 567                       | XHP35A-00-0000-0D00HD20E7 |
|             |                      |        |                |                                |                   |                    |                          |     |                           |                          | C4  | 475                       | 528                       | XHP35A-00-0000-0D00HC40E7 |
|             |                      | 90     |                |                                |                   |                    |                          |     | C2                        | 440                      | 489 | XHP35A-00-0000-0D00UC20E7 |                           |                           |
|             |                      |        |                |                                |                   |                    |                          |     | B4                        | 410                      | 456 | XHP35A-00-0000-0D00UB40E7 |                           |                           |
|             |                      |        |                |                                |                   |                    |                          |     | B2                        | 380                      | 423 | XHP35A-00-0000-0D00UB20E7 |                           |                           |
|             |                      |        |                |                                |                   |                    |                          |     |                           |                          |     |                           |                           |                           |
|             |                      | 2700 K | 8A, 8B, 8C, 8D | 80                             |                   |                    |                          |     |                           | C4                       | 475 | 528                       | XHP35A-00-0000-0D00HC40E8 |                           |
|             |                      |        |                |                                |                   |                    |                          |     |                           | C2                       | 440 | 489                       | XHP35A-00-0000-0D00HC20E8 |                           |
|             |                      |        |                | 90                             |                   |                    |                          |     |                           |                          | B4  | 410                       | 456                       | XHP35A-00-0000-0D00UB40E8 |
|             |                      |        |                |                                |                   |                    |                          |     |                           |                          | B2  | 380                       | 423                       | XHP35A-00-0000-0D00UB20E8 |

**Notes:**

- Cree maintains a tolerance of  $\pm 7\%$  on flux and power measurements,  $\pm 0.005$  on chromaticity (CCx, CCy) measurements and  $\pm 2$  on CRI measurements. See the Measurements section (page 31).
- Cree XLamp XHP35 LED order codes specify only a minimum flux bin and not a maximum. Cree may ship reels in flux bins higher than the minimum specified by the order code without advance notice. Shipments will always adhere to the chromaticity bin restrictions specified by the order code.
- \* Flux values @ 25 °C are calculated and are for reference only.

**FLUX CHARACTERISTICS, HIGH INTENSITY EASYWHITE® ORDER CODES AND BINS (T<sub>j</sub> = 85 °C)**

The following table provides order codes for XLamp XHP35 High Intensity LEDs. For a complete description of how the flux and chromaticity groups are reflected in the bin code and order code nomenclature, please see the Bin and Order Code Formats section (page 29).

| Nominal CCT | CRI    |     | Minimum Luminous Flux @350 mA |                   |                    | 3-Step                   |            | 5-Step |                          |                          |
|-------------|--------|-----|-------------------------------|-------------------|--------------------|--------------------------|------------|--------|--------------------------|--------------------------|
|             | Min    | Typ | Group                         | Flux (lm) @ 85 °C | Flux (lm) @ 25 °C* | Group                    | Order Code | Group  | Order Code               |                          |
| 5700 K      | 70     |     | D4                            | 550               | 612                |                          |            | 57E    | XHP35A-H0-0000-0D0BD457E |                          |
|             |        |     | D2                            | 510               | 567                |                          |            |        | XHP35A-H0-0000-0D0BD257E |                          |
|             |        |     | C4                            | 475               | 528                |                          |            |        | XHP35A-H0-0000-0D0BC457E |                          |
|             | 80     |     | D2                            | 510               | 567                |                          |            | 57E    | XHP35A-H0-0000-0D0HD257E |                          |
|             |        |     | C4                            | 475               | 528                |                          |            |        | XHP35A-H0-0000-0D0HC457E |                          |
|             |        |     | C2                            | 440               | 489                |                          |            |        | XHP35A-H0-0000-0D0HC257E |                          |
|             | 90     |     | C2                            | 440               | 489                |                          |            | 57E    | XHP35A-H0-0000-0D0UC257E |                          |
|             |        |     | B4                            | 410               | 456                |                          |            |        | XHP35A-H0-0000-0D0UB457E |                          |
|             |        |     | B2                            | 380               | 423                |                          |            |        | XHP35A-H0-0000-0D0UB257E |                          |
|             |        |     | A4                            | 355               | 395                |                          |            |        | XHP35A-H0-0000-0D0UA457E |                          |
|             | 5000 K | 70  |                               | D4                | 550                | 612                      |            |        | 50E                      | XHP35A-H0-0000-0D0BD450E |
|             |        |     |                               | D2                | 510                | 567                      |            |        |                          | XHP35A-H0-0000-0D0BD250E |
| C4          |        |     |                               | 475               | 528                | XHP35A-H0-0000-0D0BC450E |            |        |                          |                          |
| 80          |        |     | D2                            | 510               | 567                |                          |            | 50E    | XHP35A-H0-0000-0D0HD250E |                          |
|             |        |     | C4                            | 475               | 528                |                          |            |        | XHP35A-H0-0000-0D0HC450E |                          |
|             |        |     | C2                            | 440               | 489                |                          |            |        | XHP35A-H0-0000-0D0HC250E |                          |
| 90          |        |     | C2                            | 440               | 489                |                          |            | 50E    | XHP35A-H0-0000-0D0UC250E |                          |
|             |        |     | B4                            | 410               | 456                |                          |            |        | XHP35A-H0-0000-0D0UB450E |                          |
|             |        |     | B2                            | 380               | 423                |                          |            |        | XHP35A-H0-0000-0D0UB250E |                          |
|             |        |     | A4                            | 355               | 395                |                          |            |        | XHP35A-H0-0000-0D0UA450E |                          |

**Notes:**

- Cree maintains a tolerance of ±7% on flux and power measurements, ±0.005 on chromaticity (CCx, CCy) measurements and ±2 on CRI measurements. See the Measurements section (page 31).
- Cree XLamp XHP35 LED order codes specify only a minimum flux bin and not a maximum. Cree may ship reels in flux bins higher than the minimum specified by the order code without advance notice. Shipments will always adhere to the chromaticity bin restrictions specified by the order code.
- \* Flux values @ 25 °C are calculated and are for reference only.



**FLUX CHARACTERISTICS, HIGH INTENSITY EASYWHITE® ORDER CODES AND BINS (T<sub>j</sub> = 85 °C) - CONTINUED**

| Nominal CCT | CRI |     | Minimum Luminous Flux @350 mA |                   |                    | 3-Step |                          | 5-Step |                          |
|-------------|-----|-----|-------------------------------|-------------------|--------------------|--------|--------------------------|--------|--------------------------|
|             | Min | Typ | Group                         | Flux (lm) @ 85 °C | Flux (lm) @ 25 °C* | Group  | Order Code               | Group  | Order Code               |
| 4500 K      | 70  |     | D4                            | 550               | 612                |        |                          | 45E    | XHP35A-H0-0000-0D0BD445E |
|             |     |     | D2                            | 510               | 567                |        |                          |        | XHP35A-H0-0000-0D0BD245E |
|             |     |     | C4                            | 475               | 528                |        |                          |        | XHP35A-H0-0000-0D0BC445E |
|             | 80  |     | D2                            | 510               | 567                |        |                          | 45E    | XHP35A-H0-0000-0D0HD245E |
|             |     |     | C4                            | 475               | 528                |        |                          |        | XHP35A-H0-0000-0D0HC445E |
|             |     |     | C2                            | 440               | 489                |        |                          |        | XHP35A-H0-0000-0D0HC245E |
|             | 90  |     | B4                            | 410               | 456                |        |                          | 45E    | XHP35A-H0-0000-0D0UB445E |
|             |     |     | B2                            | 380               | 423                |        |                          |        | XHP35A-H0-0000-0D0UB245E |
|             |     |     | A4                            | 355               | 395                |        |                          |        | XHP35A-H0-0000-0D0UA445E |
| 4000 K      | 70  |     | D4                            | 550               | 612                |        |                          | 40E    | XHP35A-H0-0000-0D0BD440E |
|             |     |     | D2                            | 510               | 567                |        |                          |        | XHP35A-H0-0000-0D0BD240E |
|             |     |     | C4                            | 475               | 528                |        |                          |        | XHP35A-H0-0000-0D0BC440E |
|             |     |     | C2                            | 440               | 489                |        |                          |        | XHP35A-H0-0000-0D0BC240E |
|             | 80  |     | C4                            | 475               | 528                |        |                          | 40E    | XHP35A-H0-0000-0D0HC440E |
|             |     |     | C2                            | 440               | 489                |        |                          |        | XHP35A-H0-0000-0D0HC240E |
|             | 90  |     | B4                            | 410               | 456                |        |                          | 40E    | XHP35A-H0-0000-0D0UB440E |
|             |     |     | B2                            | 380               | 423                |        |                          |        | XHP35A-H0-0000-0D0UB240E |
|             |     |     | A4                            | 355               | 395                |        |                          |        | XHP35A-H0-0000-0D0UA440E |
| 3500 K      | 70  |     | D2                            | 510               | 567                |        |                          | 35E    | XHP35A-H0-0000-0D0BD235E |
|             |     |     | C4                            | 475               | 528                |        |                          |        | XHP35A-H0-0000-0D0BC435E |
|             |     |     | C2                            | 440               | 489                |        |                          |        | XHP35A-H0-0000-0D0BC235E |
|             | 80  |     | C4                            | 475               | 528                | 35G    | XHP35A-H0-0000-0D0HC435G | 35E    | XHP35A-H0-0000-0D0HC435E |
|             |     |     | C2                            | 440               | 489                |        | XHP35A-H0-0000-0D0HC235G |        | XHP35A-H0-0000-0D0HC235E |
|             |     |     | B4                            | 410               | 456                |        | XHP35A-H0-0000-0D0HB435G |        | XHP35A-H0-0000-0D0HB435E |
|             | 90  |     | B2                            | 380               | 423                | 35G    | XHP35A-H0-0000-0D0UB235G | 35E    | XHP35A-H0-0000-0D0UB235E |
|             |     |     | A4                            | 355               | 395                |        | XHP35A-H0-0000-0D0UA435G |        | XHP35A-H0-0000-0D0UA435E |

**Notes:**

- Cree maintains a tolerance of ±7% on flux and power measurements, ±0.005 on chromaticity (CCx, CCy) measurements and ±2 on CRI measurements. See the Measurements section (page 31).
- Cree XLamp XHP35 LED order codes specify only a minimum flux bin and not a maximum. Cree may ship reels in flux bins higher than the minimum specified by the order code without advance notice. Shipments will always adhere to the chromaticity bin restrictions specified by the order code.
- \* Flux values @ 25 °C are calculated and are for reference only.

**FLUX CHARACTERISTICS, HIGH INTENSITY EASYWHITE® ORDER CODES AND BINS (T<sub>j</sub> = 85 °C) - CONTINUED**

| Nominal CCT | CRI    |     | Minimum Luminous Flux @350 mA |                   |                    | 3-Step                   |                          | 5-Step                   |                          |
|-------------|--------|-----|-------------------------------|-------------------|--------------------|--------------------------|--------------------------|--------------------------|--------------------------|
|             | Min    | Typ | Group                         | Flux (lm) @ 85 °C | Flux (lm) @ 25 °C* | Group                    | Order Code               | Group                    | Order Code               |
| 3000 K      | 70     |     | D2                            | 510               | 567                |                          |                          | 30E                      | XHP35A-H0-0000-0D0BD230E |
|             |        |     | C4                            | 475               | 528                |                          |                          |                          | XHP35A-H0-0000-0D0BC430E |
|             |        |     | C2                            | 440               | 489                |                          |                          |                          | XHP35A-H0-0000-0D0BC230E |
|             | 80     |     | C2                            | 440               | 489                | 30G                      | XHP35A-H0-0000-0D0HC230G | 30E                      | XHP35A-H0-0000-0D0HC230E |
|             |        |     | B4                            | 410               | 456                |                          | XHP35A-H0-0000-0D0HB430G |                          | XHP35A-H0-0000-0D0HB430E |
|             | 90     |     | B2                            | 380               | 423                | 30G                      | XHP35A-H0-0000-0D0UB230G | 30E                      | XHP35A-H0-0000-0D0UB230E |
|             |        |     | A4                            | 355               | 395                |                          | XHP35A-H0-0000-0D0UA430G |                          | XHP35A-H0-0000-0D0UA430E |
|             |        |     | A2                            | 330               | 367                |                          | XHP35A-H0-0000-0D0UA230G |                          | XHP35A-H0-0000-0D0UA230E |
|             | 2700 K | 80  |                               | C2                | 440                | 489                      | 27G                      | XHP35A-H0-0000-0D0HC227G | 27E                      |
| B4          |        |     |                               | 410               | 456                | XHP35A-H0-0000-0D0HB427G |                          | XHP35A-H0-0000-0D0HB427E |                          |
| B2          |        |     |                               | 380               | 423                | XHP35A-H0-0000-0D0HB227G |                          | XHP35A-H0-0000-0D0HB227E |                          |
| 90          |        |     | A4                            | 355               | 395                | 27G                      | XHP35A-H0-0000-0D0UA427G | 27E                      | XHP35A-H0-0000-0D0UA427E |
|             |        |     | A2                            | 330               | 367                |                          | XHP35A-H0-0000-0D0UA227G |                          | XHP35A-H0-0000-0D0UA227E |

**Notes:**

- Cree maintains a tolerance of ±7% on flux and power measurements, ±0.005 on chromaticity (CCx, CCy) measurements and ±2 on CRI measurements. See the Measurements section (page 31).
- Cree XLamp XHP35 LED order codes specify only a minimum flux bin and not a maximum. Cree may ship reels in flux bins higher than the minimum specified by the order code without advance notice. Shipments will always adhere to the chromaticity bin restrictions specified by the order code.
- \* Flux values @ 25 °C are calculated and are for reference only.

**FLUX CHARACTERISTICS, HIGH INTENSITY ANSI WHITE ORDER CODES AND BINS ( $T_j = 85^\circ\text{C}$ )**

The following table provides order codes for XLamp XHP35 High Intensity LEDs. For a complete description of how the flux and chromaticity groups are reflected in the bin code and order code nomenclature, please see the Bin and Order Code Formats section (page 29).

| Nominal CCT | Chromaticity Regions   | CRI |     | Minimum Luminous Flux @ 350 mA |                   |                    | Order Code               |     |                          |
|-------------|--|-----|-----|--------------------------------|-------------------|--------------------|--------------------------|-----|--------------------------|
|             |  | Min | Typ | Group                          | Flux (lm) @ 85 °C | Flux (lm) @ 25 °C* |                          |     |                          |
| 7000 K      | 0A, 0B, 0C, 0D, 0R, 0S, 0T, 0U, 1A, 1B, 1C, 1D, 1R, 1S, 1T, 1U | 0   | 68  | D4                             | 550               | 612                | XHP35A-H0-0000-0D00D40DT |     |                          |
|             |  |     |     | D2                             | 510               | 567                | XHP35A-H0-0000-0D00D20DT |     |                          |
|             |  |     |     | C4                             | 475               | 528                | XHP35A-H0-0000-0D00C40DT |     |                          |
|             |  | 70  |     |                                |                   | D4                 | 550                      | 612 | XHP35A-H0-0000-0D0BD40DT |
|             |  |     |     |                                |                   | D2                 | 510                      | 567 | XHP35A-H0-0000-0D0BD20DT |
|             |  |     |     |                                |                   | C4                 | 475                      | 528 | XHP35A-H0-0000-0D0BC40DT |
|             |  | 80  |     |                                |                   | D2                 | 510                      | 567 | XHP35A-H0-0000-0D0HD20DT |
|             |  |     |     |                                |                   | C4                 | 475                      | 528 | XHP35A-H0-0000-0D0HC40DT |
|             |  |     |     |                                |                   | C2                 | 440                      | 489 | XHP35A-H0-0000-0D0HC20DT |
|             |  | 90  |     |                                |                   | B4                 | 410                      | 456 | XHP35A-H0-0000-0D0UB40DT |
|             |  |     |     |                                |                   | B2                 | 380                      | 423 | XHP35A-H0-0000-0D0UB20DT |
|             |  |     |     |                                |                   | A4                 | 355                      | 395 | XHP35A-H0-0000-0D0UA40DT |
| 6500 K      | 1A, 1B, 1C, 1D   | 0   | 68  | D4                             | 550               | 612                | XHP35A-H0-0000-0D00D40E1 |     |                          |
|             |  |     |     | D2                             | 510               | 567                | XHP35A-H0-0000-0D00D20E1 |     |                          |
|             |  |     |     | C4                             | 475               | 528                | XHP35A-H0-0000-0D00C40E1 |     |                          |
|             |  | 70  |     |                                |                   | D4                 | 550                      | 612 | XHP35A-H0-0000-0D0BD40E1 |
|             |  |     |     |                                |                   | D2                 | 510                      | 567 | XHP35A-H0-0000-0D0BD20E1 |
|             |  |     |     |                                |                   | C4                 | 475                      | 528 | XHP35A-H0-0000-0D0BC40E1 |
|             |  | 80  |     |                                |                   | D2                 | 510                      | 567 | XHP35A-H0-0000-0D0HD20E1 |
|             |  |     |     |                                |                   | C4                 | 475                      | 528 | XHP35A-H0-0000-0D0HC40E1 |
|             |  |     |     |                                |                   | C2                 | 440                      | 489 | XHP35A-H0-0000-0D0HC20E1 |
|             |  | 90  |     |                                |                   | B4                 | 410                      | 456 | XHP35A-H0-0000-0D0UB40E1 |
|             |  |     |     |                                |                   | B2                 | 380                      | 423 | XHP35A-H0-0000-0D0UB20E1 |
|             |  |     |     |                                |                   | A4                 | 355                      | 395 | XHP35A-H0-0000-0D0UA40E1 |

- Notes:
- Cree maintains a tolerance of  $\pm 7\%$  on flux and power measurements,  $\pm 0.005$  on chromaticity (CCx, CCy) measurements and  $\pm 2$  on CRI measurements. See the Measurements section (page 31).
  - Cree XLamp XHP35 LED order codes specify only a minimum flux bin and not a maximum. Cree may ship reels in flux bins higher than the minimum specified by the order code without advance notice. Shipments will always adhere to the chromaticity bin restrictions specified by the order code.
  - \* Flux values @ 25 °C are calculated and are for reference only.

**FLUX CHARACTERISTICS, HIGH INTENSITY ANSI ORDER CODES AND BINS ( $T_j = 85\text{ }^\circ\text{C}$ ) - CONTINUED**

| Nominal CCT | Chromaticity Regions   | CRI |     | Minimum Luminous Flux @ 350 mA |                   |                    | Order Code               |     |                          |
|-------------|--|-----|-----|--------------------------------|-------------------|--------------------|--------------------------|-----|--------------------------|
|             |  | Min | Typ | Group                          | Flux (lm) @ 85 °C | Flux (lm) @ 25 °C* |                          |     |                          |
| 6000 K      | 1A, 1B, 1C, 1D, 1R, 1S, 1T, 1U, 2A, 2B, 2C, 2D, 2R, 2S, 2T, 2U | 0   | 68  | D4                             | 550               | 612                | XHP35A-H0-0000-0D00D40DV |     |                          |
|             |  |     |     | D2                             | 510               | 567                | XHP35A-H0-0000-0D00D20DV |     |                          |
|             |  |     |     | C4                             | 475               | 528                | XHP35A-H0-0000-0D00C40DV |     |                          |
|             |  | 70  |     |                                |                   | D4                 | 550                      | 612 | XHP35A-H0-0000-0D0BD40DV |
|             |  |     |     |                                |                   | D2                 | 510                      | 567 | XHP35A-H0-0000-0D0BD20DV |
|             |  |     |     |                                |                   | C4                 | 475                      | 528 | XHP35A-H0-0000-0D0BC40DV |
|             |  | 80  |     |                                |                   | D2                 | 510                      | 567 | XHP35A-H0-0000-0D0HD20DV |
|             |  |     |     |                                |                   | C4                 | 475                      | 528 | XHP35A-H0-0000-0D0HC40DV |
|             |  |     |     |                                |                   | C2                 | 440                      | 489 | XHP35A-H0-0000-0D0HC20DV |
|             |  | 90  |     |                                |                   | C2                 | 440                      | 489 | XHP35A-H0-0000-0D0UC20DV |
|             |  |     |     |                                |                   | B4                 | 410                      | 456 | XHP35A-H0-0000-0D0UB40DV |
|             |  |     |     |                                |                   | B2                 | 380                      | 423 | XHP35A-H0-0000-0D0UB20DV |
| A4          | 355  |     |     |                                |                   | 395                | XHP35A-H0-0000-0D0UA40DV |     |                          |
| 5700 K      | 2A, 2B, 2C, 2D   | 0   | 68  | D4                             | 550               | 612                | XHP35A-H0-0000-0D00D40E2 |     |                          |
|             |  |     |     | D2                             | 510               | 567                | XHP35A-H0-0000-0D00D20E2 |     |                          |
|             |  |     |     | C4                             | 475               | 528                | XHP35A-H0-0000-0D00C40E2 |     |                          |
|             |  | 70  |     |                                |                   | D4                 | 550                      | 612 | XHP35A-H0-0000-0D0BD40E2 |
|             |  |     |     |                                |                   | D2                 | 510                      | 567 | XHP35A-H0-0000-0D0BD20E2 |
|             |  |     |     |                                |                   | C4                 | 475                      | 528 | XHP35A-H0-0000-0D0BC40E2 |
|             |  | 80  |     |                                |                   | D2                 | 510                      | 567 | XHP35A-H0-0000-0D0HD20E2 |
|             |  |     |     |                                |                   | C4                 | 475                      | 528 | XHP35A-H0-0000-0D0HC40E2 |
|             |  |     |     |                                |                   | C2                 | 440                      | 489 | XHP35A-H0-0000-0D0HC20E2 |
|             |  | 90  |     |                                |                   | C2                 | 440                      | 489 | XHP35A-H0-0000-0D0UC20E2 |
|             |  |     |     |                                |                   | B4                 | 410                      | 456 | XHP35A-H0-0000-0D0UB40E2 |
|             |  |     |     |                                |                   | B2                 | 380                      | 423 | XHP35A-H0-0000-0D0UB20E2 |
| A4          | 355  |     |     |                                |                   | 395                | XHP35A-H0-0000-0D0UA40E2 |     |                          |

**Notes:**

- Cree maintains a tolerance of  $\pm 7\%$  on flux and power measurements,  $\pm 0.005$  on chromaticity (CCx, CCy) measurements and  $\pm 2$  on CRI measurements. See the Measurements section (page 31).
- Cree XLamp XHP35 LED order codes specify only a minimum flux bin and not a maximum. Cree may ship reels in flux bins higher than the minimum specified by the order code without advance notice. Shipments will always adhere to the chromaticity bin restrictions specified by the order code.
- \* Flux values @ 25 °C are calculated and are for reference only.

**FLUX CHARACTERISTICS, HIGH INTENSITY ANSI ORDER CODES AND BINS ( $T_j = 85\text{ }^\circ\text{C}$ ) - CONTINUED**

| Nominal CCT | Chromaticity Regions | CRI |     | Minimum Luminous Flux @ 350 mA |                          |                    | Order Code               |
|-------------|----------------------|-----|-----|--------------------------------|--------------------------|--------------------|--------------------------|
|             |                      | Min | Typ | Group                          | Flux (lm) @ 85 °C        | Flux (lm) @ 25 °C* |                          |
| 5000 K      | 3A, 3B, 3C, 3D       | 0   | 68  | D4                             | 550                      | 612                | XHP35A-H0-0000-0D00D40E3 |
|             |                      |     |     | D2                             | 510                      | 567                | XHP35A-H0-0000-0D00D20E3 |
|             |                      |     |     | C4                             | 475                      | 528                | XHP35A-H0-0000-0D00C40E3 |
|             |                      | 70  |     | D4                             | 550                      | 612                | XHP35A-H0-0000-0D0BD40E3 |
|             |                      |     |     | D2                             | 510                      | 567                | XHP35A-H0-0000-0D0BD20E3 |
|             |                      |     |     | C4                             | 475                      | 528                | XHP35A-H0-0000-0D0BC40E3 |
|             |                      | 80  |     | D2                             | 510                      | 567                | XHP35A-H0-0000-0D0HD20E3 |
|             |                      |     |     | C4                             | 475                      | 528                | XHP35A-H0-0000-0D0HC40E3 |
|             |                      |     |     | C2                             | 440                      | 489                | XHP35A-H0-0000-0D0HC20E3 |
|             |                      | 90  |     | C2                             | 440                      | 489                | XHP35A-H0-0000-0D0UC20E3 |
|             |                      |     |     | B4                             | 410                      | 456                | XHP35A-H0-0000-0D0UB40E3 |
|             |                      |     |     | B2                             | 380                      | 423                | XHP35A-H0-0000-0D0UB20E3 |
| A4          | 355                  |     |     | 395                            | XHP35A-H0-0000-0D0UA40E3 |                    |                          |
| 4500 K      | 4A, 4B, 4C, 4D       | 0   | 68  | D4                             | 550                      | 612                | XHP35A-H0-0000-0D00D40E4 |
|             |                      |     |     | D2                             | 510                      | 567                | XHP35A-H0-0000-0D00D20E4 |
|             |                      |     |     | C4                             | 475                      | 528                | XHP35A-H0-0000-0D00C40E4 |
|             |                      | 70  |     | D4                             | 550                      | 612                | XHP35A-H0-0000-0D0BD40E4 |
|             |                      |     |     | D2                             | 510                      | 567                | XHP35A-H0-0000-0D0BD20E4 |
|             |                      |     |     | C4                             | 475                      | 528                | XHP35A-H0-0000-0D0BC40E4 |
|             |                      | 80  |     | D2                             | 510                      | 567                | XHP35A-H0-0000-0D0HD20E4 |
|             |                      |     |     | C4                             | 475                      | 528                | XHP35A-H0-0000-0D0HC40E4 |
|             |                      |     |     | C2                             | 440                      | 489                | XHP35A-H0-0000-0D0HC20E4 |
|             |                      | 90  |     | B4                             | 410                      | 456                | XHP35A-H0-0000-0D0UB40E4 |
|             |                      |     |     | B2                             | 380                      | 423                | XHP35A-H0-0000-0D0UB20E4 |
|             |                      |     |     | A4                             | 355                      | 395                | XHP35A-H0-0000-0D0UA40E4 |

**Notes:**

- Cree maintains a tolerance of  $\pm 7\%$  on flux and power measurements,  $\pm 0.005$  on chromaticity (CCx, CCy) measurements and  $\pm 2$  on CRI measurements. See the Measurements section (page 31).
- Cree XLamp XHP35 LED order codes specify only a minimum flux bin and not a maximum. Cree may ship reels in flux bins higher than the minimum specified by the order code without advance notice. Shipments will always adhere to the chromaticity bin restrictions specified by the order code.
- \* Flux values @ 25 °C are calculated and are for reference only.

**FLUX CHARACTERISTICS, HIGH INTENSITY ANSI ORDER CODES AND BINS (T<sub>j</sub> = 85 °C) - CONTINUED**

| Nominal CCT | Chromaticity Regions | CRI |     | Minimum Luminous Flux @ 350 mA |                   |                    | Order Code               |     |                          |                          |     |                          |
|-------------|----------------------|-----|-----|--------------------------------|-------------------|--------------------|--------------------------|-----|--------------------------|--------------------------|-----|--------------------------|
|             |                      | Min | Typ | Group                          | Flux (lm) @ 85 °C | Flux (lm) @ 25 °C* |                          |     |                          |                          |     |                          |
| 4000 K      | 5A, 5B, 5C, 5D       | 0   | 68  | D4                             | 550               | 612                | XHP35A-H0-0000-0D00D40E5 |     |                          |                          |     |                          |
|             |                      |     |     | D2                             | 510               | 567                | XHP35A-H0-0000-0D00D20E5 |     |                          |                          |     |                          |
|             |                      |     |     | C4                             | 475               | 528                | XHP35A-H0-0000-0D00C40E5 |     |                          |                          |     |                          |
|             |                      |     |     | C2                             | 440               | 489                | XHP35A-H0-0000-0D00C20E5 |     |                          |                          |     |                          |
|             |                      | 70  |     |                                |                   | D4                 | 550                      | 612 | XHP35A-H0-0000-0D0BD40E5 |                          |     |                          |
|             |                      |     |     |                                |                   | D2                 | 510                      | 567 | XHP35A-H0-0000-0D0BD20E5 |                          |     |                          |
|             |                      |     |     |                                |                   | C4                 | 475                      | 528 | XHP35A-H0-0000-0D0BC40E5 |                          |     |                          |
|             |                      |     |     |                                |                   | C2                 | 440                      | 489 | XHP35A-H0-0000-0D0BC20E5 |                          |     |                          |
|             |                      | 80  |     |                                |                   | C4                 | 475                      | 528 | XHP35A-H0-0000-0D0HC40E5 |                          |     |                          |
|             |                      |     |     |                                |                   | C2                 | 440                      | 489 | XHP35A-H0-0000-0D0HC20E5 |                          |     |                          |
|             |                      | 90  |     |                                |                   | B4                 | 410                      | 456 | XHP35A-H0-0000-0D0UB40E5 |                          |     |                          |
|             |                      |     |     |                                |                   | B2                 | 380                      | 423 | XHP35A-H0-0000-0D0UB20E5 |                          |     |                          |
| A4          | 355                  |     |     |                                |                   | 395                | XHP35A-H0-0000-0D0UA40E5 |     |                          |                          |     |                          |
| 3500 K      | 6A, 6B, 6C, 6D       | 70  |     |                                |                   |                    | D2                       | 510 | 567                      | XHP35A-H0-0000-0D0BD20E6 |     |                          |
|             |                      |     |     |                                |                   |                    | C4                       | 475 | 528                      | XHP35A-H0-0000-0D0BC40E6 |     |                          |
|             |                      |     |     |                                |                   |                    | C2                       | 440 | 489                      | XHP35A-H0-0000-0D0BC20E6 |     |                          |
|             |                      | 80  |     |                                |                   |                    |                          |     | C4                       | 475                      | 528 | XHP35A-H0-0000-0D0HC40E6 |
|             |                      |     |     |                                |                   |                    |                          |     | C2                       | 440                      | 489 | XHP35A-H0-0000-0D0HC20E6 |
|             |                      |     |     |                                |                   |                    |                          |     | B4                       | 410                      | 456 | XHP35A-H0-0000-0D0HB40E6 |
| 90          |                      |     |     |                                |                   |                    | B2                       | 380 | 423                      | XHP35A-H0-0000-0D0UB20E6 |     |                          |
|             |                      |     |     |                                |                   |                    | A4                       | 355 | 395                      | XHP35A-H0-0000-0D0UA40E6 |     |                          |
| 3000 K      | 7A, 7B, 7C, 7D       | 70  |     |                                |                   |                    | D2                       | 510 | 567                      | XHP35A-H0-0000-0D0BD20E7 |     |                          |
|             |                      |     |     |                                |                   |                    | C4                       | 475 | 528                      | XHP35A-H0-0000-0D0BC40E7 |     |                          |
|             |                      |     |     |                                |                   |                    | C2                       | 440 | 489                      | XHP35A-H0-0000-0D0BC20E7 |     |                          |
|             |                      | 80  |     |                                |                   |                    |                          |     | C2                       | 420                      | 489 | XHP35A-H0-0000-0D0HC20E7 |
|             |                      |     |     |                                |                   |                    |                          |     | B4                       | 410                      | 456 | XHP35A-H0-0000-0D0HB40E7 |
|             |                      | 90  |     |                                |                   |                    |                          |     | B2                       | 380                      | 423 | XHP35A-H0-0000-0D0UB20E7 |
| A4          | 355                  |     |     |                                |                   |                    |                          |     | 395                      | XHP35A-H0-0000-0D0UA40E7 |     |                          |
| A2          | 330                  |     |     |                                |                   |                    |                          |     | 367                      | XHP35A-H0-0000-0D0UA20E7 |     |                          |
| 2700 K      | 8A, 8B, 8C, 8D       | 80  |     |                                |                   |                    | C2                       | 420 | 489                      | XHP35A-H0-0000-0D0HC20E8 |     |                          |
|             |                      |     |     |                                |                   |                    | B4                       | 410 | 456                      | XHP35A-H0-0000-0D0HB40E8 |     |                          |
|             |                      |     |     |                                |                   |                    | B2                       | 380 | 423                      | XHP35A-H0-0000-0D0HB20E8 |     |                          |
|             |                      | 90  |     |                                |                   |                    |                          |     | A4                       | 355                      | 395 | XHP35A-H0-0000-0D0UA40E8 |
|             |                      |     |     |                                |                   |                    |                          |     | A2                       | 330                      | 367 | XHP35A-H0-0000-0D0UA20E8 |

**Notes:**

- Cree maintains a tolerance of ±7% on flux and power measurements, ±0.005 on chromaticity (CCx, CCy) measurements and ±2 on CRI measurements. See the Measurements section (page 31).
- Cree XLamp XHP35 LED order codes specify only a minimum flux bin and not a maximum. Cree may ship reels in flux bins higher than the minimum specified by the order code without advance notice. Shipments will always adhere to the chromaticity bin restrictions specified by the order code.
- \* Flux values @ 25 °C are calculated and are for reference only.

**RELATIVE SPECTRAL POWER DISTRIBUTION**

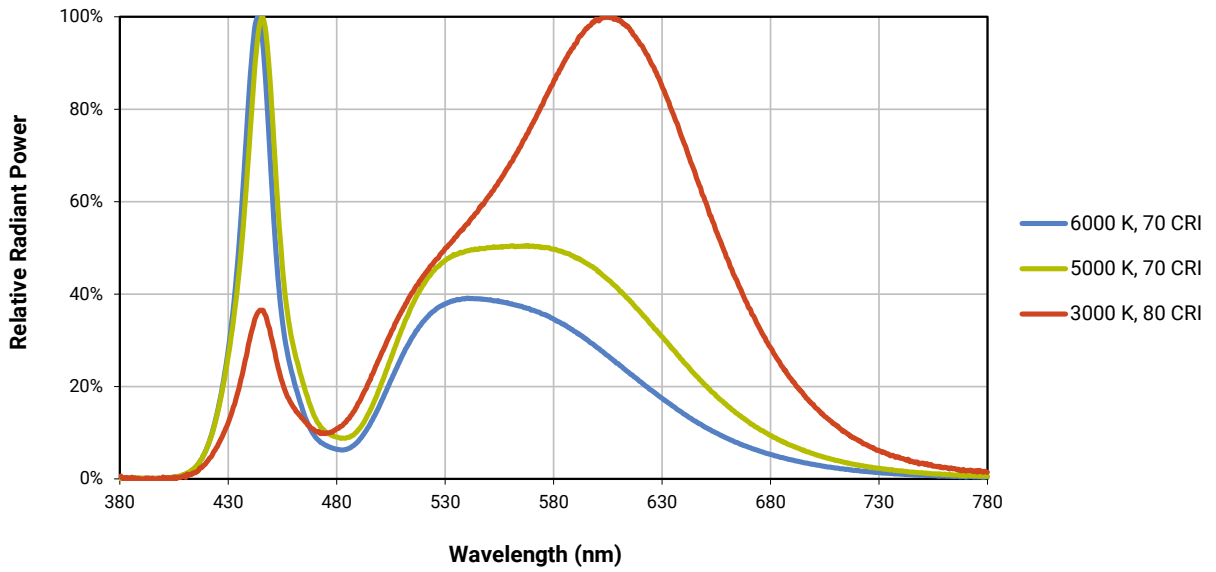

**RELATIVE FLUX VS. JUNCTION TEMPERATURE ( $I_F = 350$  mA)**

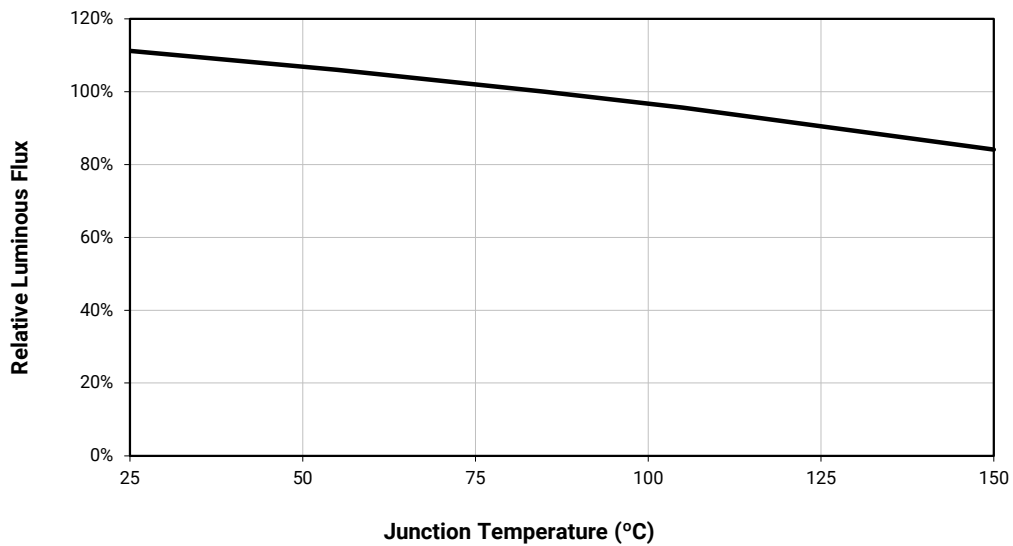

**ELECTRICAL CHARACTERISTICS ( $T_j = 85\text{ }^\circ\text{C}$ )**

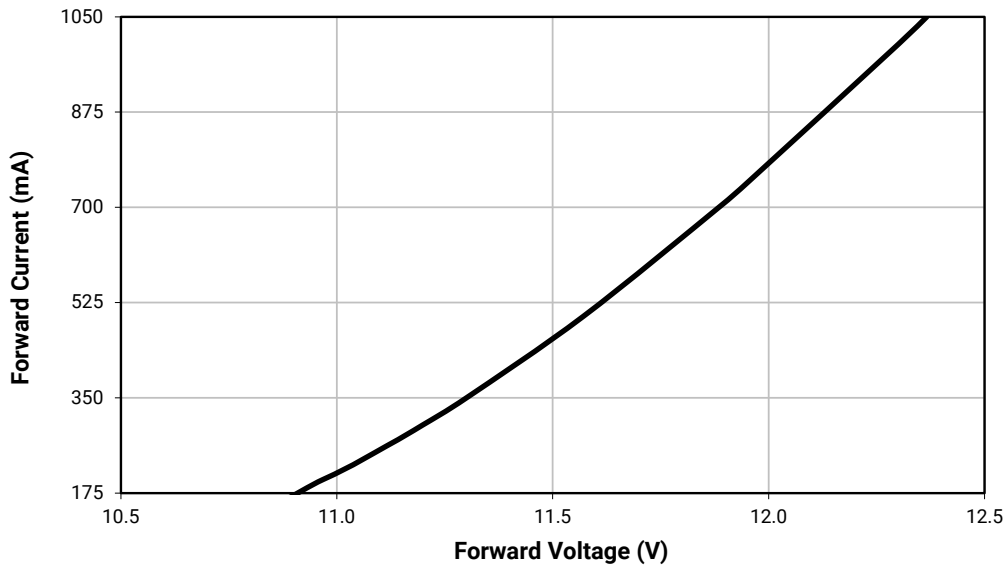

**RELATIVE FLUX VS. CURRENT ( $T_j = 85\text{ }^\circ\text{C}$ )**

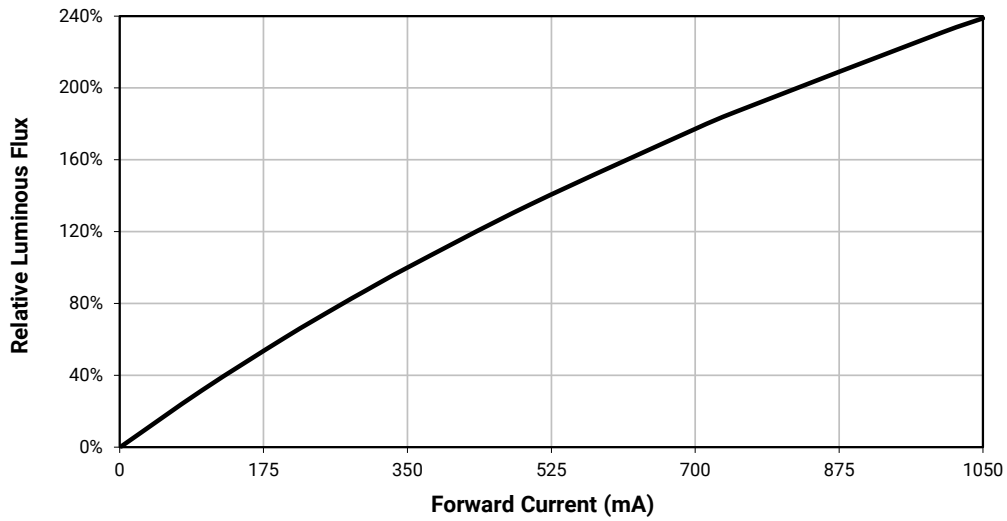



**RELATIVE CHROMATICITY VS. CURRENT (WARM WHITE)**

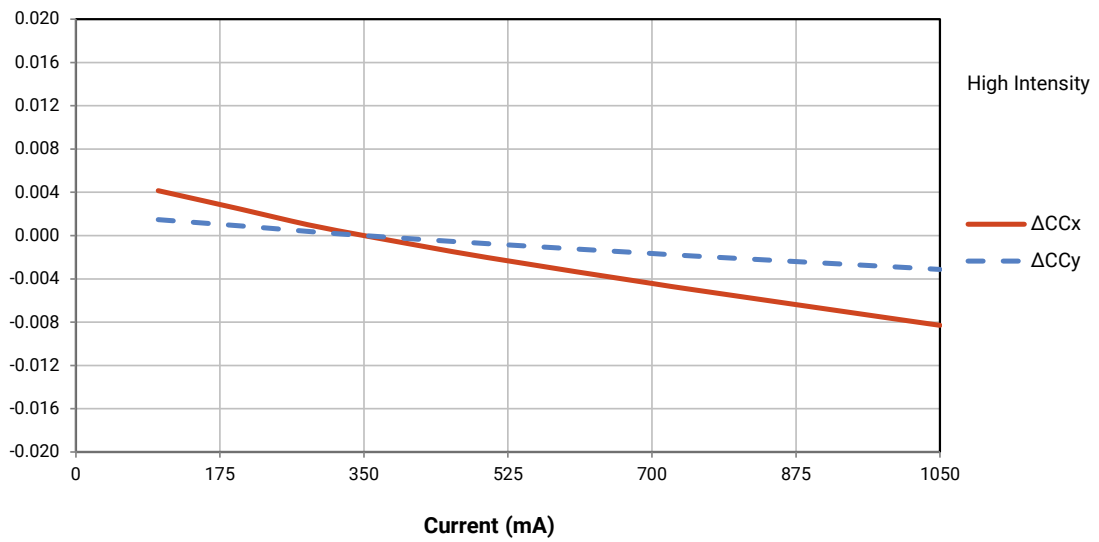
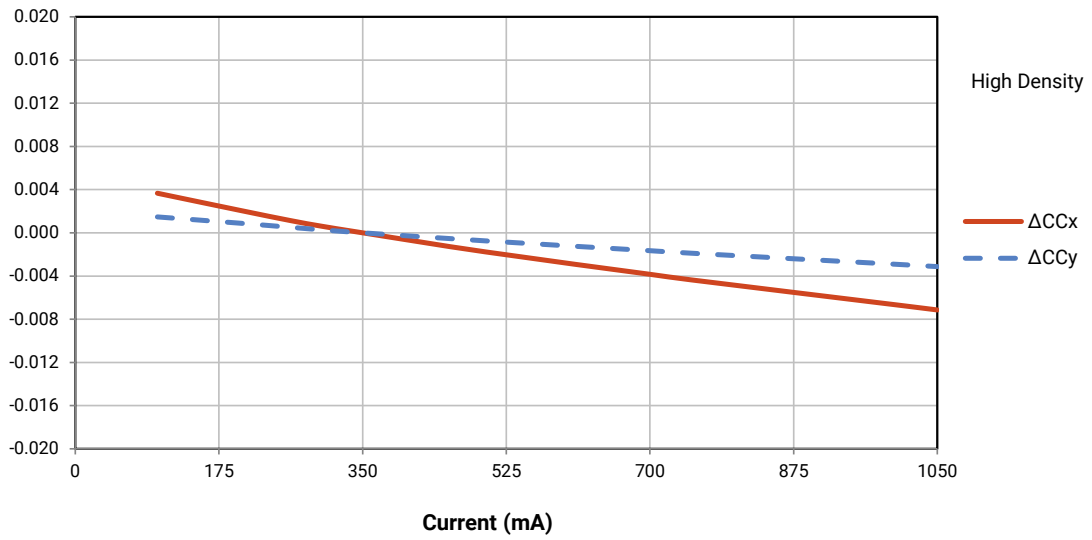

**RELATIVE CHROMATICITY VS. TEMPERATURE (WARM WHITE)**

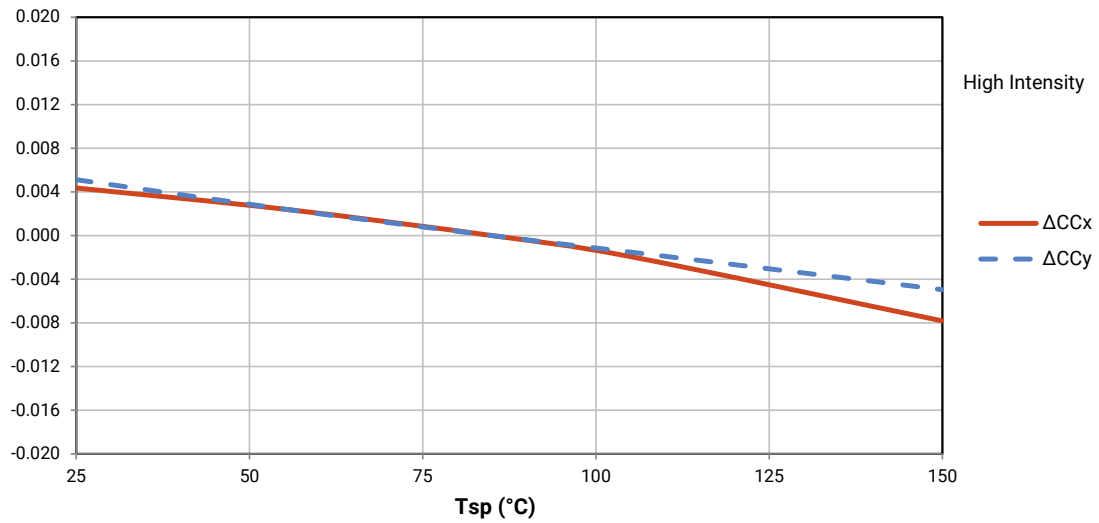
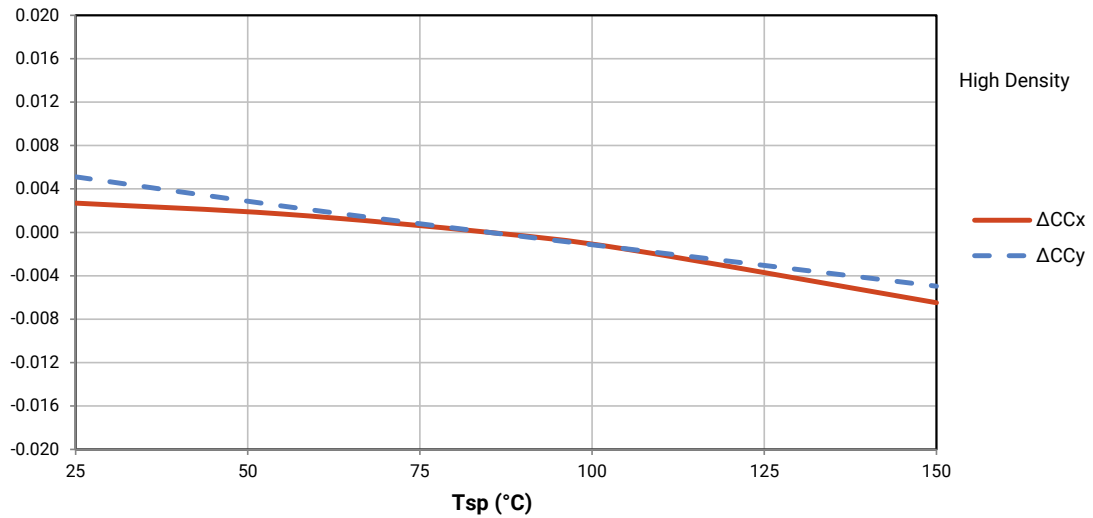

**TYPICAL SPATIAL DISTRIBUTION**

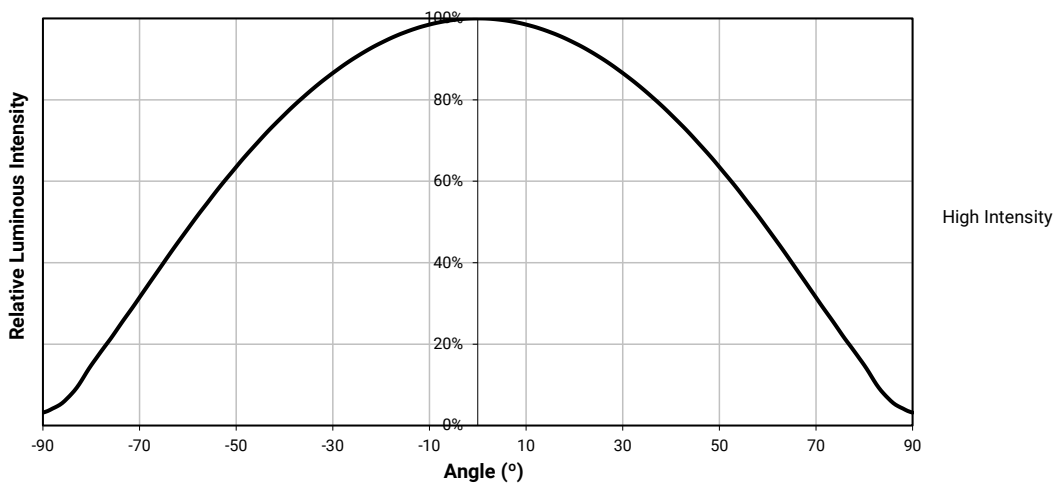
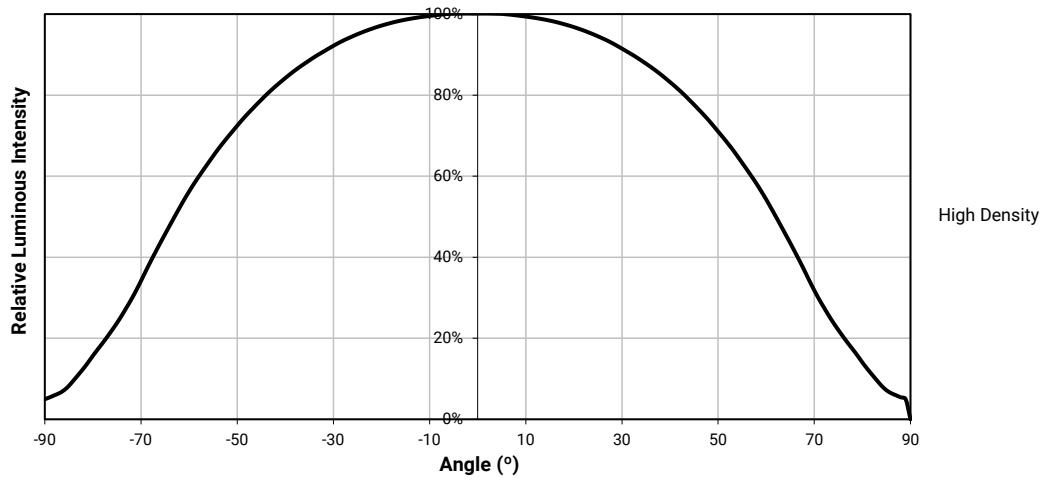

**THERMAL DESIGN**

The maximum forward current is determined by the thermal resistance between the LED junction and ambient. It is crucial for the end product to be designed in a manner that minimizes the thermal resistance from the solder point to ambient in order to optimize lamp life and optical characteristics.

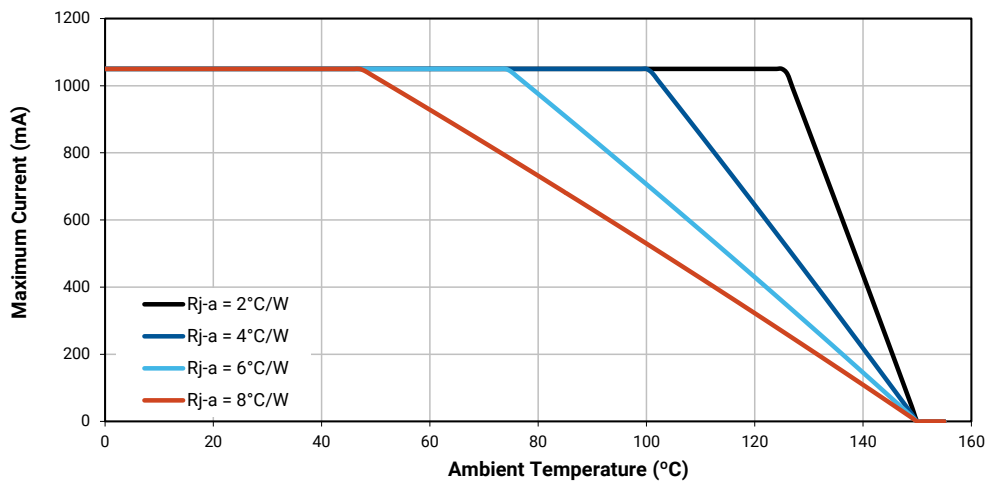

**PERFORMANCE GROUPS – LUMINOUS FLUX (T<sub>j</sub> = 85 °C)**

XLamp XHP35 LEDs are tested for luminous flux and placed into one of the following luminous-flux groups.

| Group Code | Minimum Luminous Flux | Maximum Luminous Flux |
|------------|-----------------------|-----------------------|
| A2         | 330                   | 355                   |
| A4         | 355                   | 380                   |
| B2         | 380                   | 410                   |
| B4         | 410                   | 440                   |
| C2         | 440                   | 475                   |
| C4         | 475                   | 510                   |
| D2         | 510                   | 550                   |
| D4         | 550                   | 590                   |
| E2         | 590                   | 635                   |
| E4         | 635                   | 680                   |
| F2         | 680                   | 730                   |

**PERFORMANCE GROUPS – CHROMATICITY**

XLamp XHP35 LEDs are tested for chromaticity and placed into one of the regions defined by the following bounding coordinates.

| EasyWhite Color Temperatures – 3-Step Ellipse |        |              |        |            |            |                    |
|---|--------|--------------|--------|------------|------------|--------------------|
| Bin Code                                      | CCT    | Center Point |        | Major Axis | Minor Axis | Rotation Angle (°) |
|   |        | x            | y      | a          | b          |                    |
| 35G   | 3500 K | 0.4073       | 0.3917 | 0.00927    | 0.00414    | 54.0               |
| 30G   | 3000 K | 0.4338       | 0.4030 | 0.00834    | 0.00408    | 53.2               |
| 27G   | 2700 K | 0.4577       | 0.4099 | 0.00834    | 0.00420    | 48.5               |

| EasyWhite Color Temperatures – 5-Step Ellipse |        |              |        |            |            |                    |
|---|--------|--------------|--------|------------|------------|--------------------|
| Bin Code                                      | CCT    | Center Point |        | Major Axis | Minor Axis | Rotation Angle (°) |
|   |        | x            | y      | a          | b          |                    |
| 57E   | 5700 K | 0.3287       | 0.3417 | 0.01230    | 0.00600    | 72.0               |
| 50E   | 5000 K | 0.3447       | 0.3553 | 0.01400    | 0.00520    | 65.0               |
| 45E   | 4500 K | 0.3611       | 0.3658 | 0.01420    | 0.00550    | 61.5               |
| 40E   | 4000 K | 0.3818       | 0.3797 | 0.01565    | 0.00670    | 53.7               |
| 35E   | 3500 K | 0.4073       | 0.3917 | 0.01545    | 0.00690    | 54.0               |
| 30E   | 3000 K | 0.4338       | 0.4030 | 0.01390    | 0.00680    | 53.2               |
| 27E   | 2700 K | 0.4577       | 0.4099 | 0.01350    | 0.00700    | 48.5               |

| ANSI White Bins |          |        |        |
|-----------------|----------|--------|--------|
| CCT             | Bin Code | x      | y      |
| 7000 K          | 0A0      | 0.2950 | 0.2970 |
|                 |          | 0.2920 | 0.3060 |
|                 |          | 0.2984 | 0.3133 |
|                 |          | 0.3009 | 0.3042 |
|                 | 0B0      | 0.2920 | 0.3060 |
|                 |          | 0.2895 | 0.3135 |
|                 |          | 0.2962 | 0.3220 |
|                 |          | 0.2984 | 0.3133 |
|                 | 0C0      | 0.2984 | 0.3133 |
|                 |          | 0.2962 | 0.3220 |
|                 |          | 0.3028 | 0.3304 |
|                 |          | 0.3048 | 0.3207 |
|                 | 0D0      | 0.2984 | 0.3133 |
|                 |          | 0.3048 | 0.3207 |
|                 |          | 0.3068 | 0.3113 |
|                 |          | 0.3009 | 0.3042 |

| ANSI White Bins |          |        |        |
|-----------------|----------|--------|--------|
| CCT             | Bin Code | x      | y      |
| 7000 K          | 0R0      | 0.2980 | 0.2880 |
|                 |          | 0.2950 | 0.2970 |
|                 |          | 0.3009 | 0.3042 |
|                 |          | 0.3037 | 0.2937 |
|                 | 0S0      | 0.2895 | 0.3135 |
|                 |          | 0.2870 | 0.3210 |
|                 |          | 0.2937 | 0.3312 |
|                 |          | 0.2962 | 0.3220 |
|                 | 0T0      | 0.2962 | 0.3220 |
|                 |          | 0.2937 | 0.3312 |
|                 |          | 0.3005 | 0.3415 |
|                 |          | 0.3028 | 0.3304 |
|                 | 0U0      | 0.3037 | 0.2937 |
|                 |          | 0.3009 | 0.3042 |
|                 |          | 0.3068 | 0.3113 |
|                 |          | 0.3093 | 0.2993 |

**PERFORMANCE GROUPS – CHROMATICITY (CONTINUED)**

| ANSI White Bins |          |        |        |
|-----------------|----------|--------|--------|
| CCT             | Bin Code | x      | y      |
| 6500 K          | 1A0      | 0.3048 | 0.3207 |
|                 |          | 0.3130 | 0.3290 |
|                 |          | 0.3144 | 0.3186 |
|                 |          | 0.3068 | 0.3113 |
|                 | 1B0      | 0.3028 | 0.3304 |
|                 |          | 0.3115 | 0.3391 |
|                 |          | 0.3130 | 0.3290 |
|                 |          | 0.3048 | 0.3207 |
|                 | 1C0      | 0.3115 | 0.3391 |
|                 |          | 0.3205 | 0.3481 |
|                 |          | 0.3213 | 0.3373 |
|                 |          | 0.3130 | 0.3290 |
|                 | 1D0      | 0.3130 | 0.3290 |
|                 |          | 0.3213 | 0.3373 |
|                 |          | 0.3221 | 0.3261 |
|                 |          | 0.3144 | 0.3186 |

| ANSI White Bins |          |        |        |
|-----------------|----------|--------|--------|
| CCT             | Bin Code | x      | y      |
| 6500 K          | 1R0      | 0.3068 | 0.3113 |
|                 |          | 0.3144 | 0.3186 |
|                 |          | 0.3161 | 0.3059 |
|                 |          | 0.3093 | 0.2993 |
|                 | 1S0      | 0.3005 | 0.3415 |
|                 |          | 0.3099 | 0.3509 |
|                 |          | 0.3115 | 0.3391 |
|                 |          | 0.3028 | 0.3304 |
|                 | 1T0      | 0.3099 | 0.3509 |
|                 |          | 0.3196 | 0.3602 |
|                 |          | 0.3205 | 0.3481 |
|                 |          | 0.3115 | 0.3391 |
|                 | 1U0      | 0.3144 | 0.3186 |
|                 |          | 0.3221 | 0.3261 |
|                 |          | 0.3231 | 0.3120 |
|                 |          | 0.3161 | 0.3059 |

| ANSI White Bins |          |        |        |
|-----------------|----------|--------|--------|
| CCT             | Bin Code | x      | y      |
| 5700 K          | 2A0      | 0.3215 | 0.3350 |
|                 |          | 0.3290 | 0.3417 |
|                 |          | 0.3290 | 0.3300 |
|                 |          | 0.3222 | 0.3243 |
|                 | 2B0      | 0.3207 | 0.3462 |
|                 |          | 0.3290 | 0.3538 |
|                 |          | 0.3290 | 0.3417 |
|                 |          | 0.3215 | 0.3350 |
|                 | 2C0      | 0.3290 | 0.3538 |
|                 |          | 0.3376 | 0.3616 |
|                 |          | 0.3371 | 0.3490 |
|                 |          | 0.3290 | 0.3417 |
|                 | 2D0      | 0.3290 | 0.3417 |
|                 |          | 0.3371 | 0.3490 |
|                 |          | 0.3366 | 0.3369 |
|                 |          | 0.3290 | 0.3300 |

| ANSI White Bins |          |        |        |
|-----------------|----------|--------|--------|
| CCT             | Bin Code | x      | y      |
| 5700 K          | 2R0      | 0.3222 | 0.3243 |
|                 |          | 0.3290 | 0.3300 |
|                 |          | 0.3290 | 0.3180 |
|                 |          | 0.3231 | 0.3120 |
|                 | 2S0      | 0.3196 | 0.3602 |
|                 |          | 0.3290 | 0.3690 |
|                 |          | 0.3290 | 0.3538 |
|                 |          | 0.3207 | 0.3462 |
|                 | 2T0      | 0.3290 | 0.3690 |
|                 |          | 0.3381 | 0.3762 |
|                 |          | 0.3376 | 0.3616 |
|                 |          | 0.3290 | 0.3538 |
|                 | 2U0      | 0.3290 | 0.3300 |
|                 |          | 0.3366 | 0.3369 |
|                 |          | 0.3361 | 0.3245 |
|                 |          | 0.3290 | 0.3180 |

**PERFORMANCE GROUPS – CHROMATICITY (CONTINUED)**

| ANSI White Bins |          |        |        |
|-----------------|----------|--------|--------|
| CCT             | Bin Code | x      | y      |
| 5000 K          | 3A0      | 0.3371 | 0.3490 |
|                 |          | 0.3451 | 0.3554 |
|                 |          | 0.3440 | 0.3427 |
|                 |          | 0.3366 | 0.3369 |
|                 | 3B0      | 0.3376 | 0.3616 |
|                 |          | 0.3463 | 0.3687 |
|                 |          | 0.3451 | 0.3554 |
|                 |          | 0.3371 | 0.3490 |
|                 | 3C0      | 0.3463 | 0.3687 |
|                 |          | 0.3551 | 0.3760 |
|                 |          | 0.3533 | 0.3620 |
|                 |          | 0.3451 | 0.3554 |
|                 | 3D0      | 0.3451 | 0.3554 |
|                 |          | 0.3533 | 0.3620 |
|                 |          | 0.3515 | 0.3487 |
|                 |          | 0.3440 | 0.3427 |

| ANSI White Bins |          |        |        |
|-----------------|----------|--------|--------|
| CCT             | Bin Code | x      | y      |
| 4500 K          | 4A0      | 0.3530 | 0.3597 |
|                 |          | 0.3615 | 0.3659 |
|                 |          | 0.3512 | 0.3465 |
|                 |          | 0.3515 | 0.3487 |
|                 | 4B0      | 0.3548 | 0.3736 |
|                 |          | 0.3641 | 0.3804 |
|                 |          | 0.3530 | 0.3597 |
|                 |          | 0.3533 | 0.3620 |
|                 | 4C0      | 0.3641 | 0.3804 |
|                 |          | 0.3736 | 0.3874 |
|                 |          | 0.3702 | 0.3722 |
|                 |          | 0.3615 | 0.3659 |
|                 | 4D0      | 0.3615 | 0.3659 |
|                 |          | 0.3702 | 0.3722 |
|                 |          | 0.3670 | 0.3578 |
|                 |          | 0.3590 | 0.3521 |

| ANSI White Bins |          |        |        |
|-----------------|----------|--------|--------|
| CCT             | Bin Code | x      | y      |
| 4000 K          | 5A0      | 0.3670 | 0.3578 |
|                 |          | 0.3702 | 0.3722 |
|                 |          | 0.3825 | 0.3798 |
|                 |          | 0.3783 | .3646  |
|                 | 5B0      | 0.3702 | 0.3722 |
|                 |          | 0.3736 | 0.3874 |
|                 |          | 0.3869 | 0.3958 |
|                 |          | 0.3825 | 0.3798 |
|                 | 5C0      | 0.3825 | 0.3798 |
|                 |          | 0.3869 | 0.3958 |
|                 |          | .04006 | 0.4044 |
|                 |          | 0.3950 | 0.3875 |
|                 | 5D0      | 0.3783 | 0.3646 |
|                 |          | 0.3825 | 0.3798 |
|                 |          | 0.3950 | 0.3875 |
|                 |          | 0.3898 | 0.3716 |

| ANSI White Bins |          |        |        |
|-----------------|----------|--------|--------|
| CCT             | Bin Code | x      | y      |
| 3500 K          | 6A0      | 0.3889 | 0.3690 |
|                 |          | 0.3941 | 0.3848 |
|                 |          | 0.4080 | 0.3916 |
|                 |          | 0.4017 | 0.3751 |
|                 | 6B0      | 0.3941 | 0.3848 |
|                 |          | 0.3996 | 0.4015 |
|                 |          | .04146 | 0.4089 |
|                 |          | .04080 | 0.3916 |
|                 | 6C0      | 0.4080 | 0.3916 |
|                 |          | 0.4146 | 0.4089 |
|                 |          | 0.4299 | 0.4165 |
|                 |          | 0.4221 | 0.3984 |
|                 | 6D0      | 0.4017 | 0.3751 |
|                 |          | 0.4080 | 0.3916 |
|                 |          | 0.4221 | 0.3984 |
|                 |          | 0.4147 | 0.3814 |

**PERFORMANCE GROUPS - CHROMATICITY (CONTINUED)**

| ANSI White Bins |          |        |        | ANSI White Bins |          |        |        |
|-----------------|----------|--------|--------|-----------------|----------|--------|--------|
| CCT             | Bin Code | x      | y      | CCT             | Bin Code | x      | y      |
| 3000 K          | 7A0      | 0.4147 | 0.3814 | 2700 K          | 8A0      | 0.4373 | 0.3893 |
|                 |          | 0.4221 | 0.3984 |                 |          | 0.4465 | 0.4071 |
|                 |          | 0.4342 | 0.4028 |                 |          | 0.4582 | 0.4099 |
|                 |          | 0.4259 | 0.3853 |                 |          | 0.4483 | 0.3919 |
|                 | 7B0      | 0.4221 | 0.3984 |                 | 8B0      | 0.4465 | 0.4071 |
|                 |          | 0.4299 | 0.4165 |                 |          | 0.4562 | 0.4260 |
|                 |          | 0.4430 | 0.4212 |                 |          | 0.4687 | 0.4289 |
|                 |          | 0.4342 | 0.4028 |                 |          | 0.4582 | 0.4099 |
|                 | 7C0      | 0.4342 | 0.4028 |                 | 8C0      | 0.4582 | 0.4099 |
|                 |          | 0.4430 | 0.4212 |                 |          | 0.4687 | 0.4289 |
|                 |          | 0.4562 | 0.4260 |                 |          | 0.4813 | 0.4319 |
|                 |          | 0.4465 | 0.4071 |                 |          | 0.4700 | 0.4126 |
|                 | 7D0      | 0.4259 | 0.3853 |                 | 8D0      | 0.4483 | 0.3919 |
|                 |          | 0.4342 | 0.4028 |                 |          | 0.4582 | 0.4099 |
|                 |          | 0.4465 | 0.4071 |                 |          | 0.4700 | 0.4126 |
|                 |          | 0.4373 | 0.3893 |                 |          | 0.4593 | 0.3944 |

**CREE'S EASYWHITE® CHROMATICITY REGIONS PLOTTED ON THE 1931 CIE CURVE**

ANSI Cool White

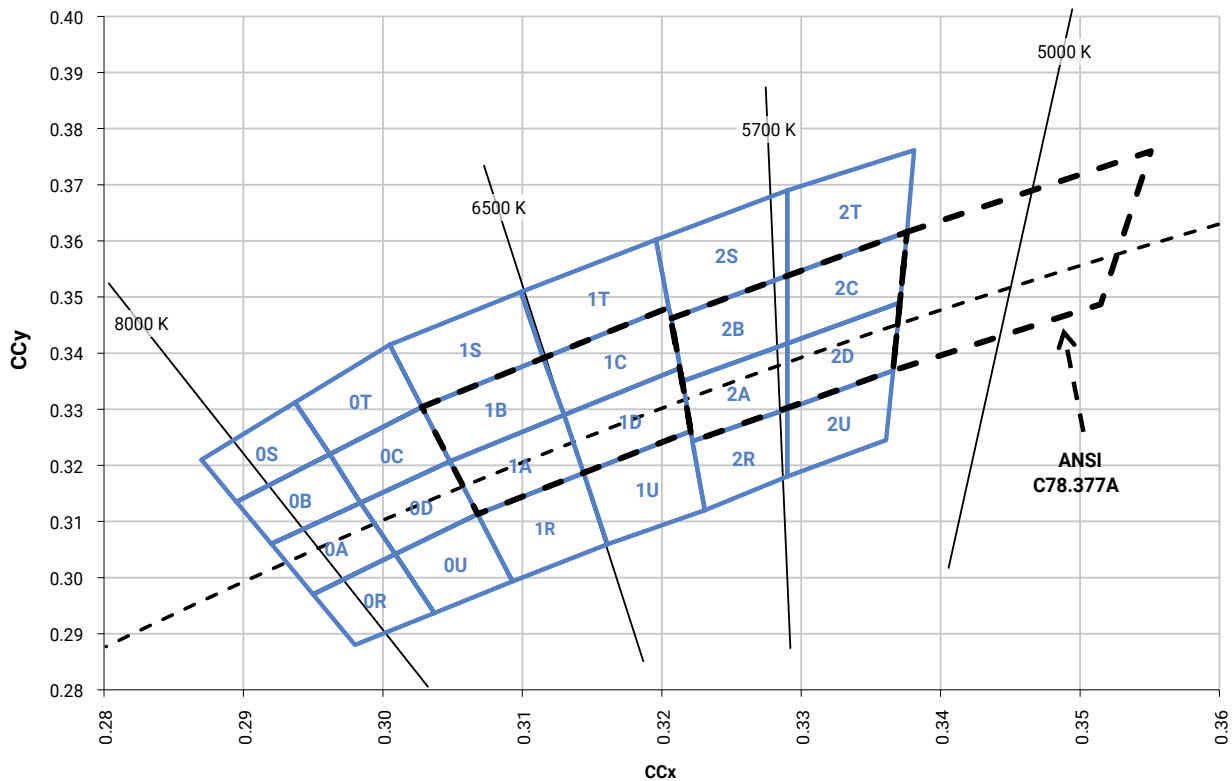



**CREE'S EASYWHITE® CHROMATICITY REGIONS PLOTTED ON THE 1931 CIE CURVE - CONTINUED**

ANSI Neutral White and ANSI Warm White

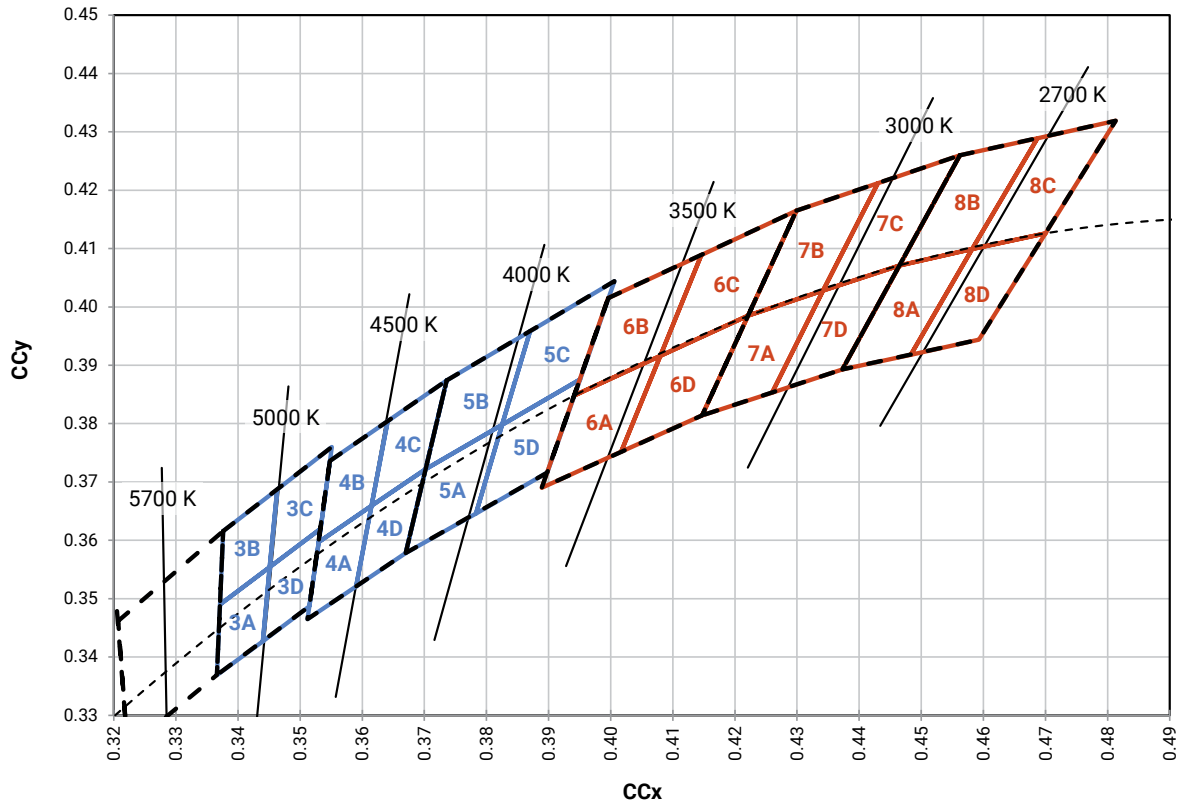

**CREE'S EASYWHITE® CHROMATICITY REGIONS PLOTTED ON THE 1931 CIE CURVE - CONTINUED**

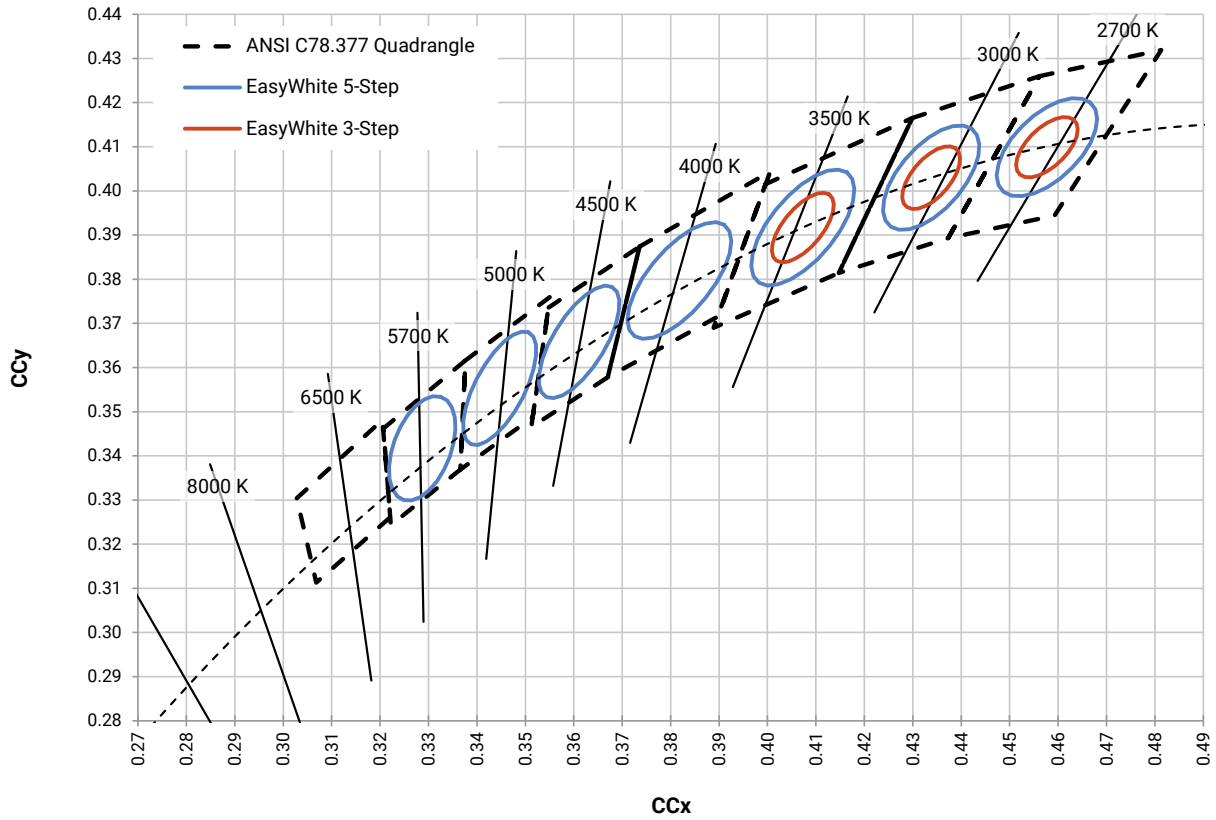

**CREE'S STANDARD COOL WHITE KITS PLOTTED ON ANSI STANDARD CHROMATICITY REGIONS**

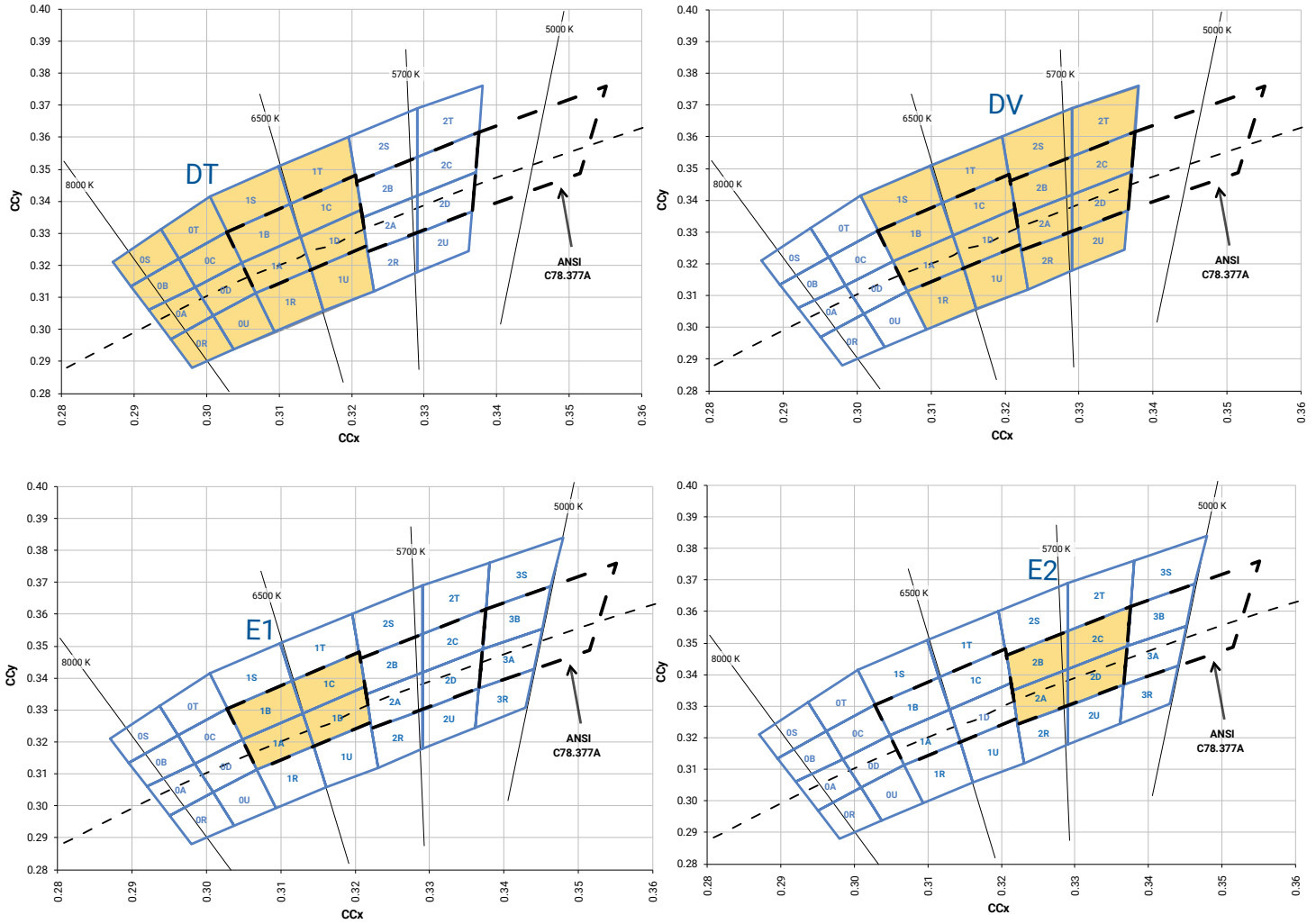

**CREE'S STANDARD WARM AND NEUTRAL WHITE KITS PLOTTED ON ANSI STANDARD CHROMATICITY REGIONS**

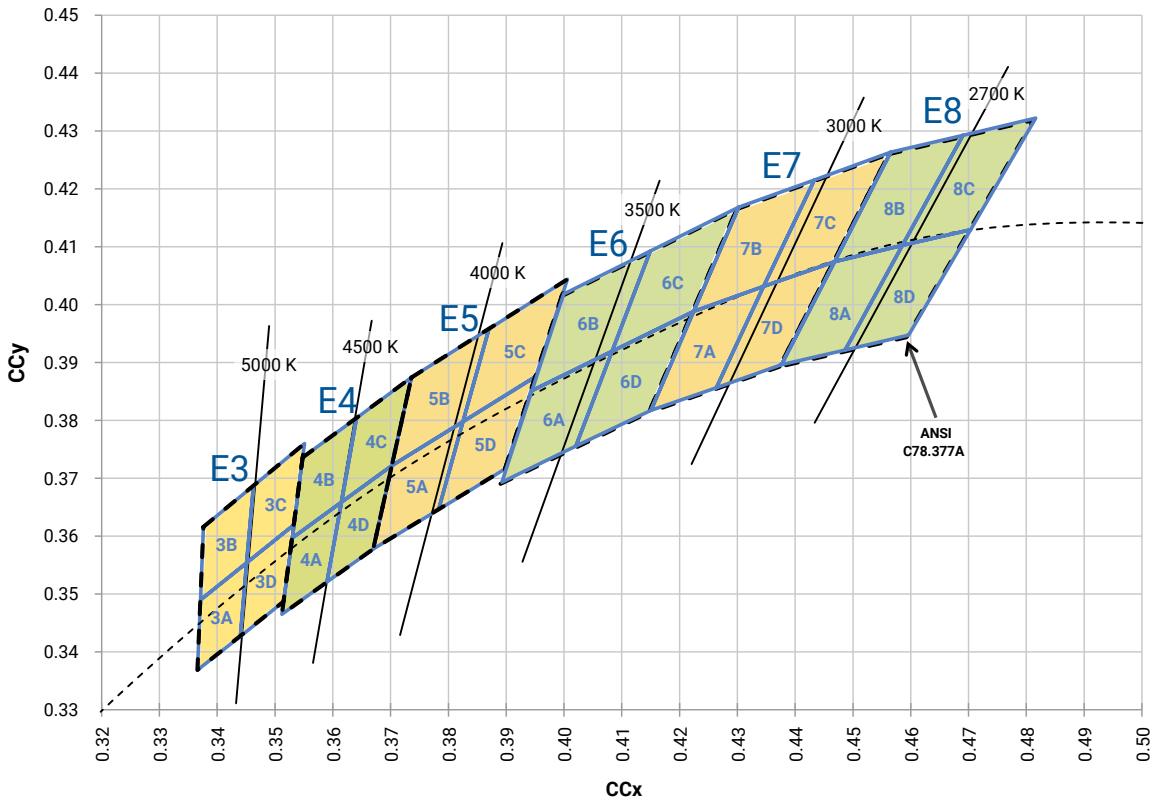

**BIN AND ORDER CODE FORMATS**

Bin codes and order codes for XHP35 LEDs are configured in the following manner:

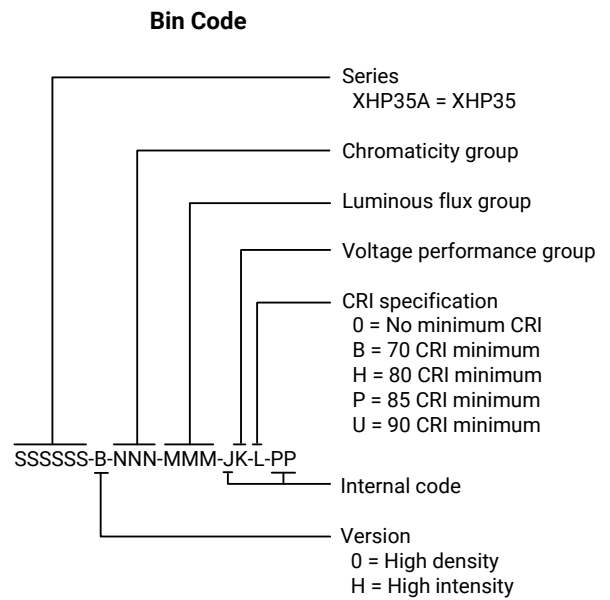
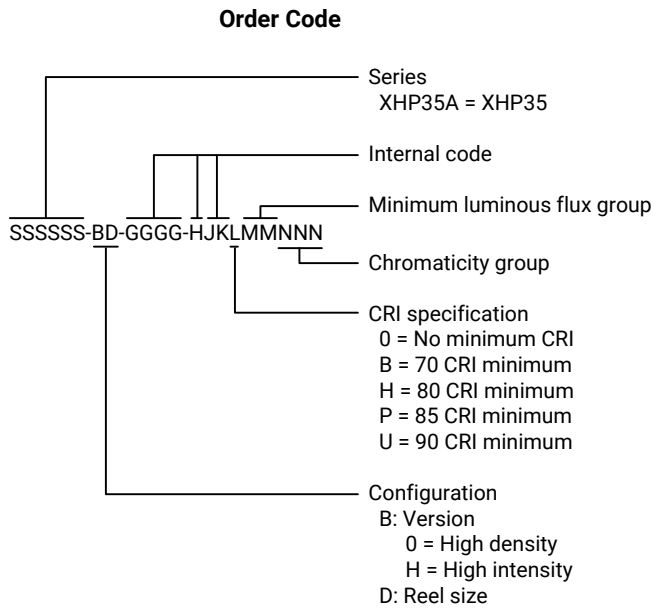

**REFLOW SOLDERING CHARACTERISTICS**

In testing, Cree has found XLamp XHP35 LEDs to be compatible with JEDEC J-STD-020C, using the parameters listed below. As a general guideline, Cree recommends that users follow the recommended soldering profile provided by the manufacturer of the solder paste used.

Note that this general guideline may not apply to all PCB designs and configurations of reflow soldering equipment.

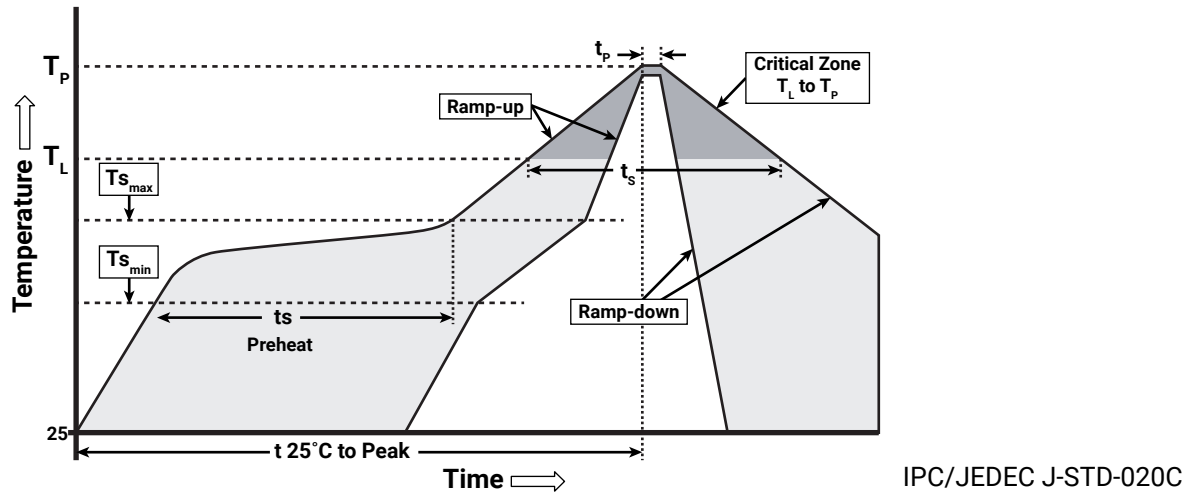

| Profile Feature                                       | Lead-Free Solder |
|---|------------------|
| Average Ramp-Up Rate ( $T_{s_{max}}$ to $T_P$ )       | 1.2 °C/second    |
| Preheat: Temperature Min ( $T_{s_{min}}$ )            | 120 °C           |
| Preheat: Temperature Max ( $T_{s_{max}}$ )            | 170 °C           |
| Preheat: Time ( $t_{s_{min}}$ to $t_{s_{max}}$ )      | 65-150 seconds   |
| Time Maintained Above: Temperature ( $T_L$ )          | 217 °C           |
| Time Maintained Above: Time ( $t_s$ )                 | 45-90 seconds    |
| Peak/Classification Temperature ( $T_P$ )             | 235 - 245 °C     |
| Time Within 5 °C of Actual Peak Temperature ( $t_p$ ) | 20-40 seconds    |
| Ramp-Down Rate  | 1 - 6 °C/second  |
| Time 25 °C to Peak Temperature                        | 4 minutes max.   |

Note: All temperatures refer to the topside of the package, measured on the package body surface.

## NOTES

---

### Measurements

The luminous flux, radiant power, chromaticity and CRI measurements in this document are binning specifications only and solely represent product measurements as of the date of shipment. These measurements will change over time based on a number of factors that are not within Cree's control and are not intended or provided as operational specifications for the products. Calculated values are provided for informational purposes only and are not intended as specifications.

### Pre-Release Qualification Testing

Please read the [LED Reliability Overview](#) for details of the qualification process Cree applies to ensure long-term reliability for XLamp LEDs and details of Cree's pre-release qualification testing for XLamp LEDs.

### Lumen Maintenance

Cree now uses standardized IES LM-80-08 and TM-21-11 methods for collecting long-term data and extrapolating LED lumen maintenance. For information on the specific LM-80 data sets available for this LED, refer to the public [LM-80 results document](#).

Please read the [Long-Term Lumen Maintenance application note](#) for more details on Cree's lumen maintenance testing and forecasting. Please read the [Thermal Management application note](#) for details on how thermal design, ambient temperature, and drive current affect the LED junction temperature.

### Moisture Sensitivity

Cree recommends keeping XLamp LEDs in the provided, resealable moisture-barrier packaging (MBP) until immediately prior to soldering. Unopened MBPs that contain XLamp LEDs do not need special storage for moisture sensitivity.

Once the MBP is opened, XLamp XHP35 LEDs may be stored as MSL 1 per JEDEC J-STD-033, meaning they have unlimited floor life in conditions of  $\leq 30$  °C/85% relative humidity (RH). Regardless of the storage condition, Cree recommends sealing any unsoldered LEDs in the original MBP.

### RoHS Compliance

The levels of RoHS restricted materials in this product are below the maximum concentration values (also referred to as the threshold limits) permitted for such substances, or are used in an exempted application, in accordance with EU Directive 2011/65/EC (RoHS2), as implemented January 2, 2013. RoHS Declarations for this product can be obtained from your Cree representative or from the Product Documentation sections of [www.cree.com](http://www.cree.com).

### REACH Compliance

REACH substances of very high concern (SVHCs) information is available for this product. Since the European Chemical Agency (ECHA) has published notice of their intent to frequently revise the SVHC listing for the foreseeable future, please contact a Cree representative to insure you get the most up-to-date REACH SVHC Declaration. REACH banned substance information (REACH Article 67) is also available upon request.

**NOTES - CONTINUED**

---

**UL® Recognized Component**

Level 4 enclosure consideration. The LED package or a portion thereof has been investigated as a fire and electrical enclosure per ANSI/UL 8750.

**Vision Advisory**

WARNING: Do not look at exposed lamp in operation. Eye injury can result. For more information about LEDs and eye safety, please refer to the [LED Eye Safety application note](#).



**MECHANICAL DIMENSIONS**

Thermal vias, if present, are not shown on these drawings.

All dimensions are  $\pm .13$  mm unless otherwise indicated.

**XHP35 High Density**

XHP35A-0x-xxxx-xxxxxxxxx  
 XHP35 High Density

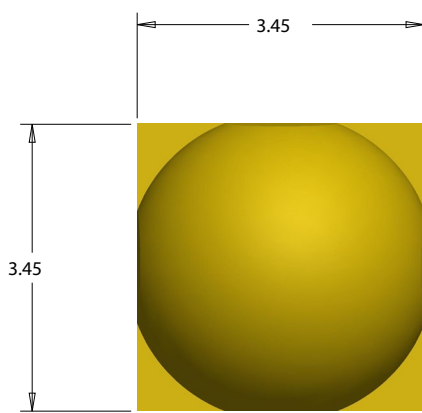

**Top View**

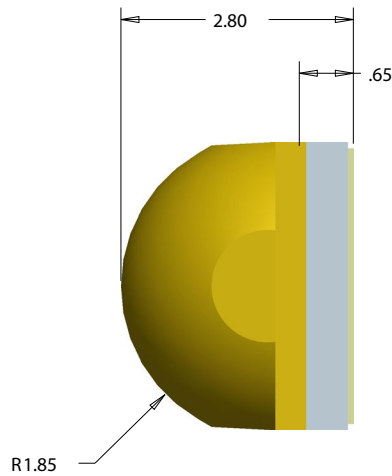

**Side View**

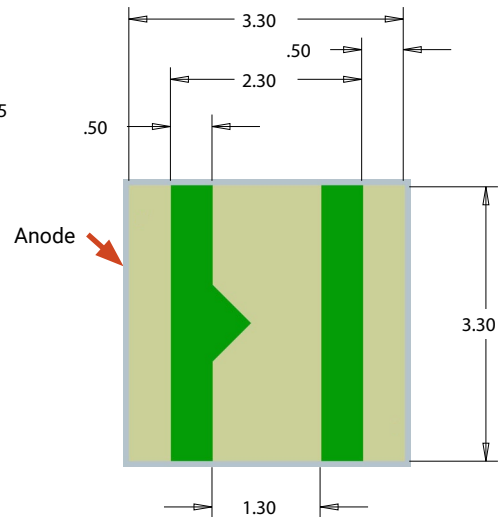

**Bottom View**

**XHP35 High Intensity**

XHP35A-Hx-xxxx-xxxxxxxxx  
 XHP35 High Intensity

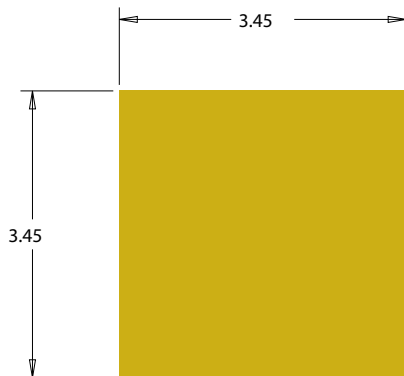

**Top View**

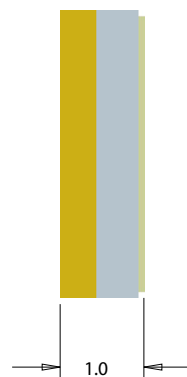

**Side View**

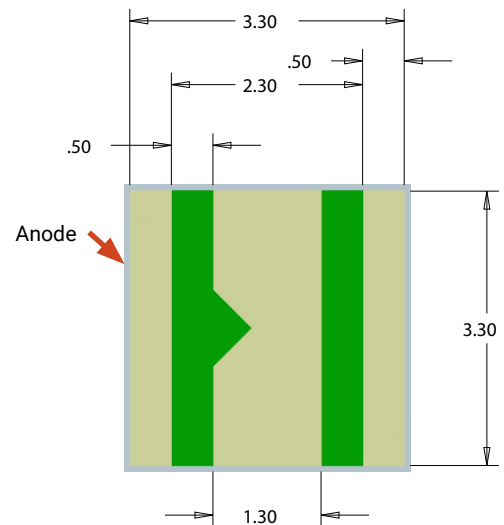

**Bottom View**

**MECHANICAL DIMENSIONS - CONTINUED**

**XHP35 High Density and XHP35 High Intensity**

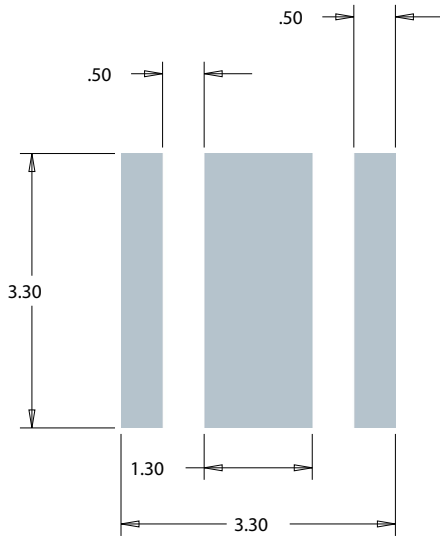

**Recommended PCB Solder Pad**

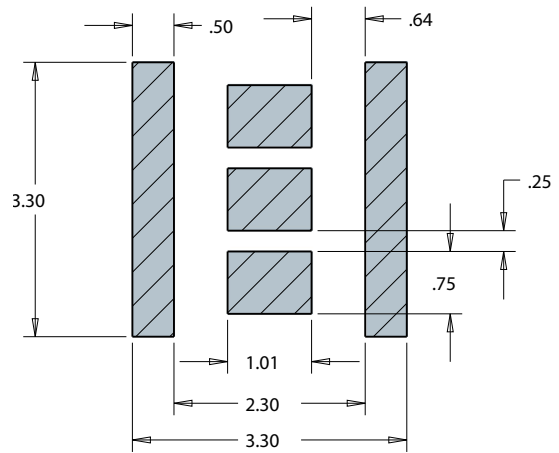

**Recommended Stencil Pattern  
(Hatched Area Is Open)**

**TAPE AND REEL**

All Cree carrier tapes conform to EIA-481D, Automated Component Handling Systems Standard.

Except as noted, all dimensions in mm [inches]

**XHP35 High Density**

XHP35A-0x-xxxx-xxxxxxxxxx

XHP35 High Density

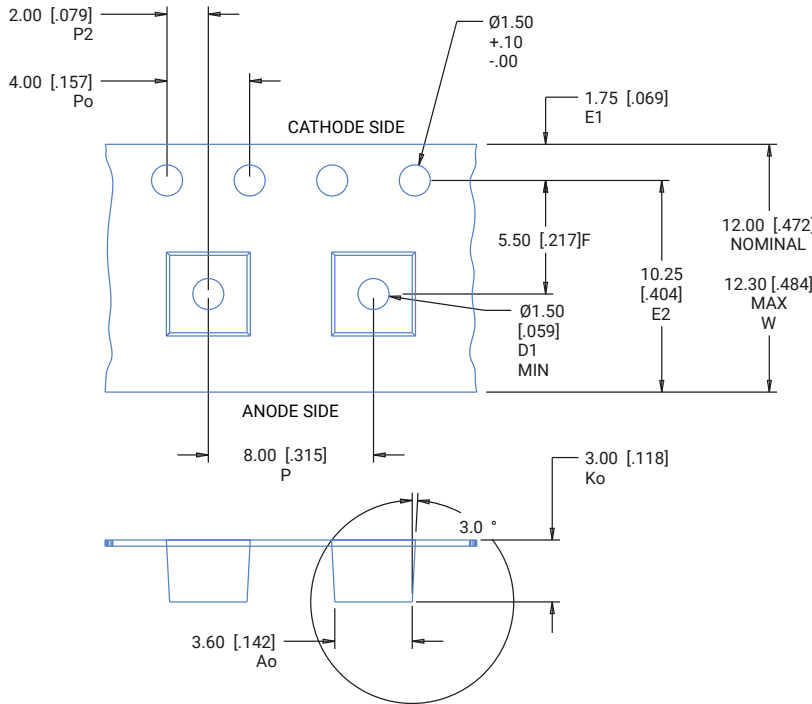

| POCKET SIZE |                 |
|-------------|-----------------|
| Ao -        | 3.60 mm [.142"] |
| Bo -        | 3.60 mm [.142"] |
| Ko -        | 3.00 mm [.118"] |

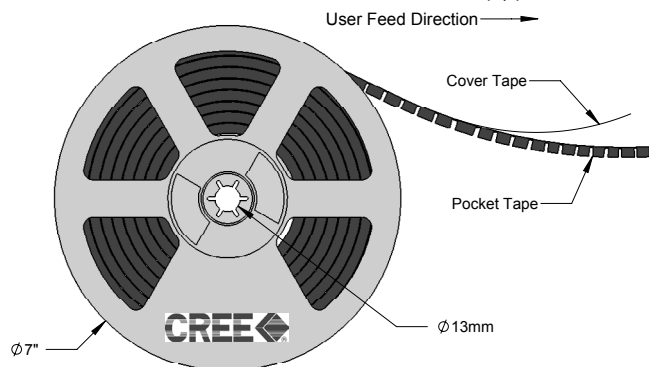
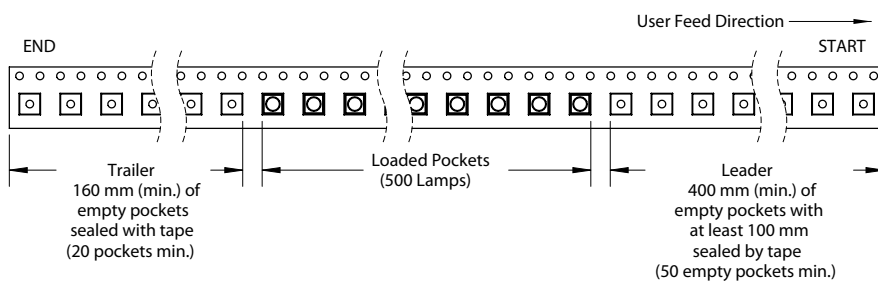
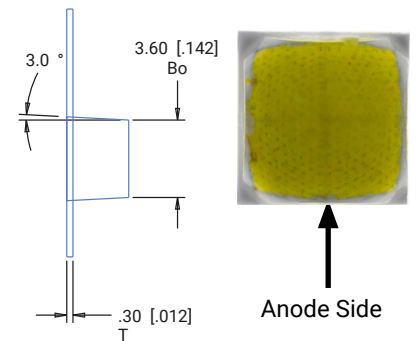

**TAPE AND REEL - CONTINUED**

**XHP35 High Intensity**

XHP35A-Hx-xxxx-xxxxxxxxxx

XHP35 High Intensity

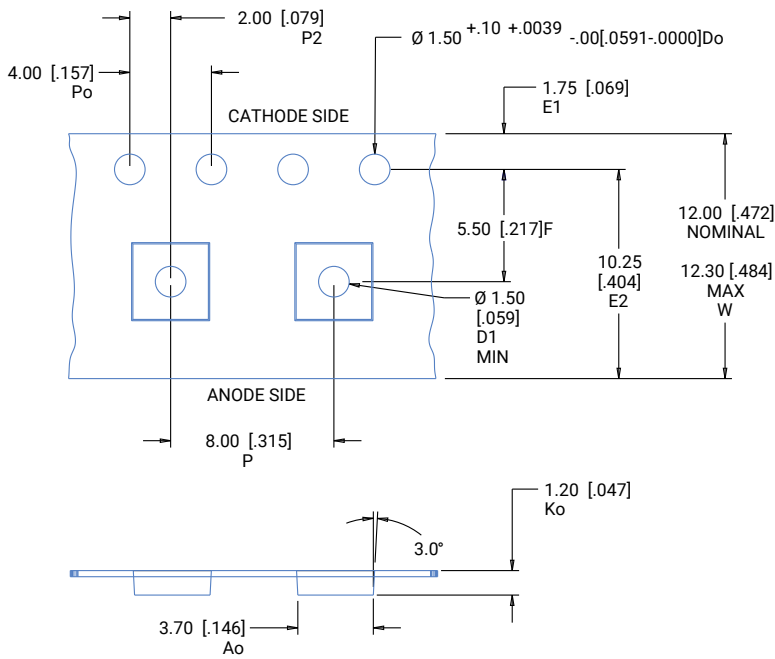

| POCKET SIZE |                 |
|-------------|-----------------|
| Ao -        | 3.70 mm [.146"] |
| Bo -        | 3.70 mm [.146"] |
| Ko -        | 1.20 mm [.047"] |

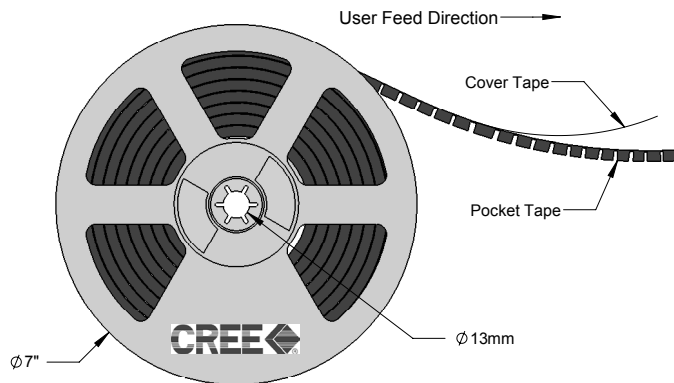
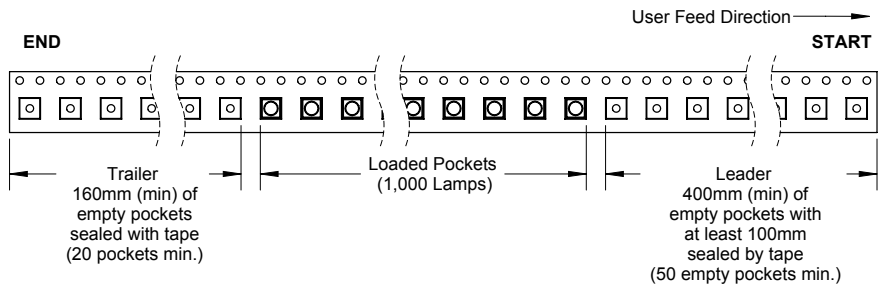
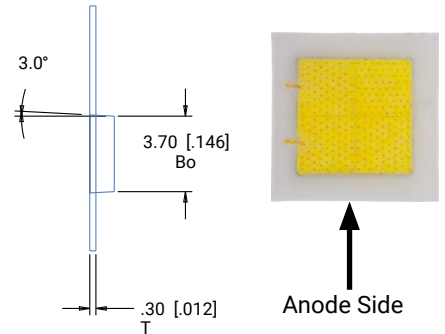

**PACKAGING**

**Unpackaged Reel**

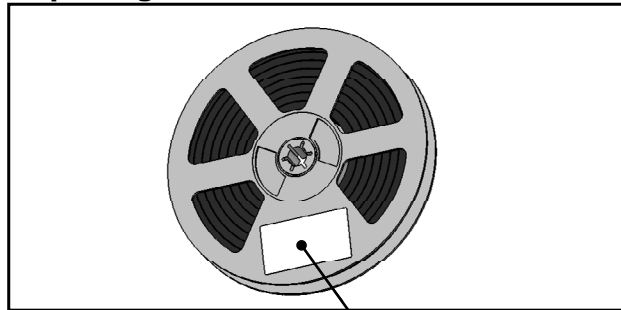

Label with Cree Bin Code,  
Quantity, Reel ID

**Packaged Reel**

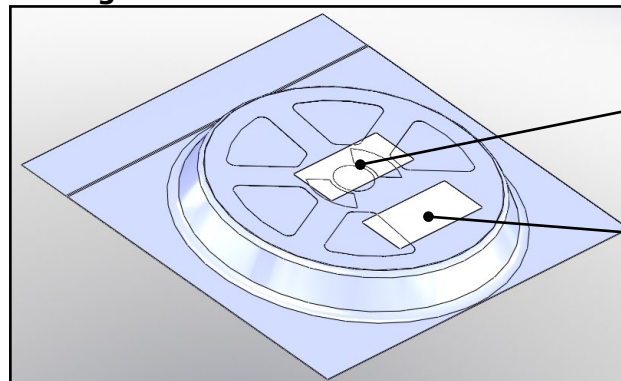

Label with Cree Order Code,  
Quantity, Reel ID, PO #

Label with Cree Bin Code,  
Quantity, Reel ID

**Boxed Reel**

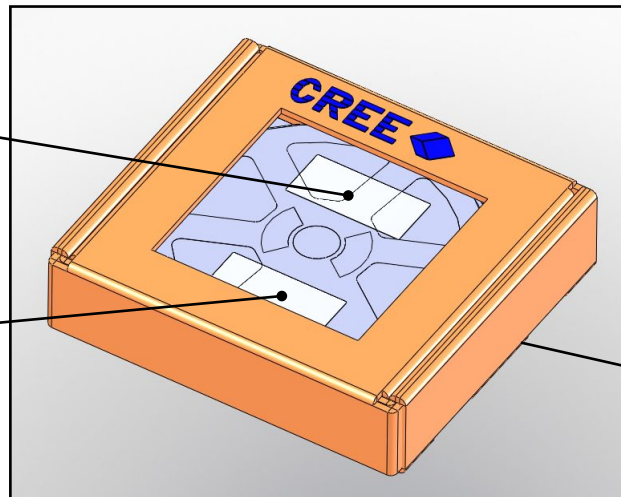

Label with Cree Order Code,  
Quantity, Reel ID, PO #

Label with Cree Bin Code,  
Quantity, Reel ID

Patent Label  
(on bottom of box)