



NAMIBIA NATIONAL  
FARMERS UNION

# Joint Presidency Committee



NAMIBIA AGRICULTURAL  
UNION



## THE ELEPHANTS OF NORTH-WESTERN NAMIBIA

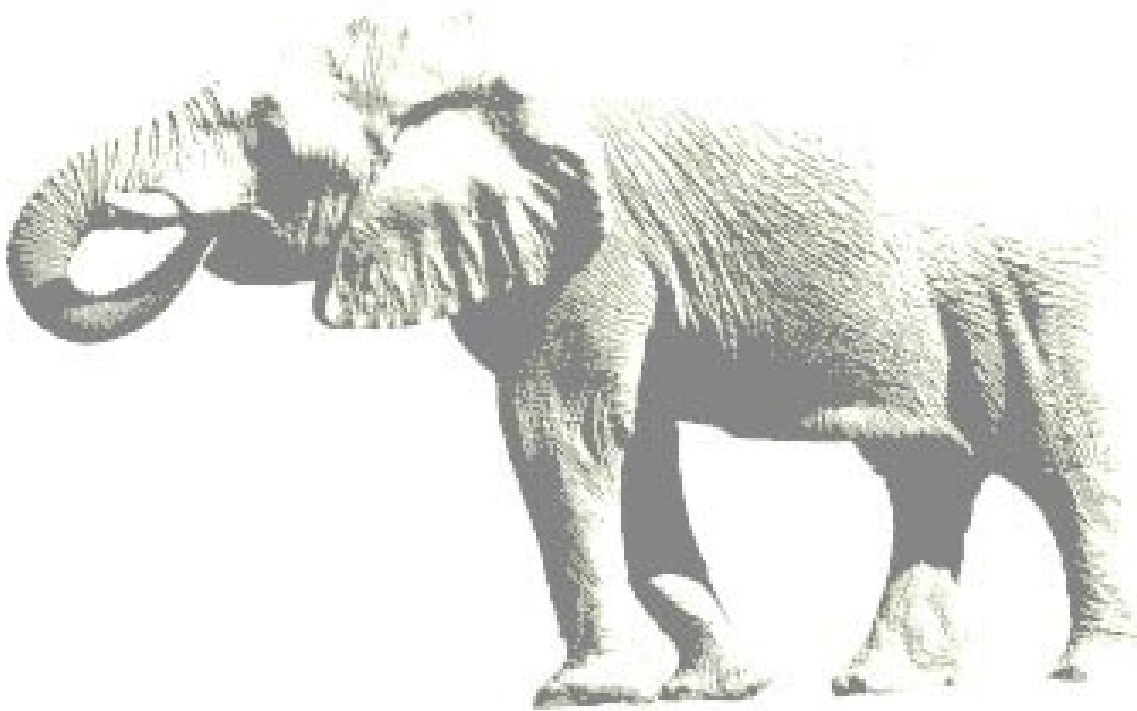

### Options for Management

An Analysis by R.B. Martin

October 2009



EMBASSY OF FINLAND  
WINDHOEK

# THE ELEPHANTS OF NORTH-WESTERN NAMIBIA

## Options for Management

### CONTENTS

Foreword.....	v
Prologue .....	vi
EXECUTIVE SUMMARY.....	vii
INTRODUCTION.....	1
A STATEMENT OF THE PROBLEM.....	4
ANALYSIS.....	6
1. The North-West Study Area.....	6
2. The Elephant Population.....	8
3. Carrying Capacities and Population Growth Rates.....	10
(1) Elephants.....	10
(2) People.....	12
4. A Simulation Model.....	15
MANAGEMENT OPTIONS.....	19
DISCUSSION.....	32
RECOMMENDATIONS.....	39
1. Short-term measures.....	39
2. Longer term options.....	42
REFERENCES.....	66

### APPENDICES

1. Carrying capacities for people in Kunene Region.....	43
2. Simulation of the Elephant Population in Kunene Region.....	46
3. Reproductive Parameters and Population Simulation Model.....	52
4. Automatic Setting of Quotas for Elephant Trophy Hunting.....	57
5. Farms visited by elephants in the Kamanjab-Outjo commercial farming area.....	58
6. Water supplies for elephant.....	59
7. Wildlife, Livestock and Food Security in the South East Lowveld of Zimbabwe.....	60
8. Empowering local communities to conserve and manage natural resources..... ( <i>Resolution adopted by the World Conservation Congress in October 2008</i> )	62
9. CITES, Elephants and Namibia.....	64

---

### List of Figures

1.	Kunene Region land categories . . . . .	6
2.	Elephant numbers in the Kaokoveld in 1970 . . . . .	8
3.	North-west elephants – Survey data 1998-2000 . . . . .	8
4.	Elephant stocking level and rate of growth in relation to rainfall . . . . .	10
5.	Distribution of wildlife and livestock in Kunene Region in 2000 . . . . .	12
6.	Carrying capacity for people . . . . .	12
7.	Communal land population increase, shrinking range for elephants and expected decline of the elephant population. . . . .	13
8.	Kunene Region simulation model . . . . .	15
9.	Dynamics of the Kunene Region elephant population under no management . . . . .	16
10.	The north-west elephant population under various management treatments . . . . .	20
11.	Emigration from the north-west under various management scenarios . . . . .	21
12.	Sustainable trophy hunting quotas in the north-west . . . . .	22
13.	Required culling offtakes under the management scenarios . . . . .	24
14.	Possible Sink Areas in the North-West . . . . .	39
A1.1	NW Rainfall and conservancies . . . . .	43
A1.2	Rainfall and human densities . . . . .	45
A2.1	Kunene Region simulation model – 1995, 1996, 1997, 2010, 2011 . . . . .	49
A6.1	Elephant drinking trough . . . . .	59

### List of Tables

1.	Kunene Region areas in various land categories . . . . .	7
2.	Proportions of Kunene Region in rainfall isohyets . . . . .	7
3.	Potential elephant population in Kunene Region without people . . . . .	11
4.	Net income from major culls in 2010 . . . . .	26
5.	Average total income from elephant management . . . . .	27
6.	Net income possible from destroying all elephants entering private land . . . . .	29
7.	Net income possible from elephants on commercial farm land in Kunene Region . . . . .	30
A1.1	Relationship between human densities and rainfall in the north-west . . . . .	44

---

## ACRONYMS

CIFOR	Centre for International Forestry Research
CITES	Convention on International Trade in Endangered Species of Wild Flora and Fauna
DSS	Directorate of Scientific Services (Ministry of Environment and Tourism, Namibia)
ECF	Emerging Commercial Farmers
EEI	Etosha Ecological Institute
HWC	Human-Wildlife Conflict
ICEMA	Integrated Community-based Ecosystem Management
IRDNC	Integrated Rural Development and Nature Conservation
JPC	Joint Presidency Committee
MET	Ministry of Environment and Tourism, Namibia
NNFU	Namibia National Farmers Union
NAU	Namibia Agricultural Union
LSU	Livestock Unit
SEL	South East Lowveld (Zimbabwe)
WWF LIFE	– World Wide Fund for Nature – Living in a Finite Environment programme

---

---

## ACKNOWLEDGEMENTS

I owe an enormous debt of gratitude to Annetjie du Preez from the Namibia Agricultural Union who organised this consultancy, shepherded it through all its stages and has tolerated with much understanding the numerous delays in its finalisation. I thank also her husband Pierre who was intimately involved in the project, helped with the logistics and gave me valuable data.

I thank Jon Barnes (whose economic reports I have made much use of over the years and who rallied to the cause and provided me with last-minute data needed for this report), Rudi Loutit (who contributed much information on the last elephant plan and more on this), Garth Owen-Smith (whose reports from his early days as an Agricultural Officer in the north-west provided certain key information in this study) and Jo Tagg (who has been a stalwart throughout).

From the Ministry of Environment and Tourism, I thank Ben Beytell (who has lent considerable support to this project), Peter Erb (who, as usual, has been the efficient supplier of large amounts of data), Werner Kilian (with whom I have spent much time discussing the Etosha elephants), Piet Burger (Otjiwarongo), Gary Nekongo (Opuwo), Erwin Tjikua and Siegfried Gawiseb (Outjo).

Once again on my Namibian work I have been able draw on the consolidated experience of many colleagues and friends: Chris Brown, Chris Eyre, Brian Jones, Bertus Kruger, Keith Leggatt Malan and Pauline Lindeque, and Polla Swart.

I thank all those Kamanjab farmers who tolerated my questions and showed me great hospitality including, but not limited to, John van der Westhuizen, Japie Avis, Dr E.E. Kessler, Dr. Sartorius von Bach, Will Gundeling, Hubertus Kreiner, Frankie Robbertse and Karel Kruger (who took me to the communal land farms and introduced me to many local people). I was honoured to be a guest at the Kamanjab Boerevereniging annual Christmas Party on Ermo farm where I not only learnt a great deal but also enjoyed myself enormously. Above all, I thank Steyn and Gaby Labuschagne from Masuren who hosted me throughout my stay – at very short notice.

I count myself fortunate to have enjoyed the open discussions I had with the people of ≠Khoadi-/Hôas Conservancy including the Chair, David Googaseb; the traditional leader Titus; Markus Kanuseb, Sessaja Aibeb, Petrus Iombo, Alfreda Hoas, Julia Somses, Otto Hannaseb and Elieser (Emmanuel Pos 1) and Titus Goachab, Ezekiel Hamkana and Koekemoer (Emmanuel Pos 2). I thank Gustav Chimuchiva (Uukwaluudhi Conservancy Senior Game Guard) for valuable discussions which covered a considerable geographic area north of Etosha.

Debbie and Colin Craig once again allowed me to descend on their house for my stay in Windhoek and provided me not only with hospitality but also with key data relevant to this study.

Marshall Murphree gave me the benefit of his vast experience on the institutional issues affecting people and wildlife much of which has been included in this report.

Finally, I thank David Cumming for all the discussions I have had with him surrounding this project and for his good-humoured tolerance of my intrusions into his own busy life.

---

## **Foreword**

**By Honourable Minister N. Nandi-Ndaitwah**

5 March 2010

All land in Namibia falls in arid and semi-arid dry lands which are very vulnerable and prone to land degradation. The majority of the population is dependent on the production of their land and its natural resources. Optimal sustainable land use for the livelihoods of the people of Namibia is of utmost importance, especially in our country with unpredictable climate conditions. Planning appropriate land use practices is critical and is determined by environmental as well as economical circumstances which dictate the optimum use of that land.

A Species Management Plan for Elephants was approved by the Ministry of Environment & Tourism in 2006, of which this area specific plan was done to fit within the National Plan and Namibia International obligations. This is an initiative of the agricultural communities in the NW of Namibia.

This area specific plan for the NW elephant population clearly indicate that the elephant population outside Etosha has been increasing steadily since 1990 and in recent years a continuous escalation of conflict with the farming communities surrounding the western half of Etosha extending to Kamanjab, Outjo and Otjiwarongo has been recorded.

Although no-one will dispute the incredible experience of sighting elephants in these extreme desert areas, these areas will not be able to support the increasing numbers of elephants due to the aridity of the area, increasing human populations together with their increasing livestock numbers.

The challenge for us is therefore to be respectful to each others preference for land use practices and to find a balance with continuously adapting our management style to be able to continue with a long-term financially viable land use practice. Conflict with wildlife is not a new problem and will continue to exist in future, but this joint venture between the Joint Presidency Committee and the Ministry of Environment & Tourism is a practical example of government and Namibian citizens looking at adaptable options and solutions for the human-elephant conflict situation.

It has also to be noted that the options for management of the NW Elephant Population is the work of the Joint Presidency Committee in Partnership with the Ministry of Environment and Tourism (MET). However, it can be adapted to other parts of the country, while taking into consideration specific conditions in those areas.

---

## Prologue

This project arose from a request from the Joint Presidency Committee (JPC) – comprising the Namibia Agricultural Union (NAU), the Namibia National Farmers Union (NNFU) and the Emerging Commercial Farmers (ECF) acting as a national producers' body for the livestock industry – for a proposal to address the management of elephants in the north-west of Namibia.

The prerogative for developing an 'elephant management plan' rests with the Ministry of Environment and Tourism. This document analyses the situation in the north-west, examines the options for management and makes recommendations. It does not purport to be a 'management plan' as such but it contains all the material necessary for the Ministry to prepare a management plan if the recommendations are acceptable.

A valid question is whether a 'management plan' is necessary. The new national policy on human-wildlife conflict<sup>1</sup> provides a framework for implementing the recommendations. In turn, the recommendations are based largely on adaptive management which preclude any rigid plan.

A presentation of the first draft of this report was given to two meetings of the Joint Presidency Committee in Windhoek (22nd and 23rd September), a meeting of farmers in Outjo (30th September), MET staff at Okakuejo (1st October), the Directorates of Parks and Scientific Services in Windhoek (5th October), Ministry of Agriculture (6th October), the senior staff of the Ministry of Environment and Tourism (6th October) and the Livestock Producers Organisation Annual Congress in Windhoek (7th October).

Very little adverse comment was received in the course of these meetings and, generally, there was strong support for the recommendations. Some modifications have been made to the original draft report of August 2009 as a result of comments received both in writing and verbally in the course of the presentations in September and October 2009.

---

1. The National Policy on Human-Wildlife Conflict Management.(MET 2009) was adopted after this consultancy was completed in August 2009.

## EXECUTIVE SUMMARY

This study was carried out for the Joint Presidency Committee (JPC) of Namibia acting as a national producers' body for the livestock industry. The JPC comprises the Namibia Agricultural Union (NAU), the Namibia National Farmers Union (NNFU) and the Emerging Commercial Farmers (ECF). The need for the study arose from the escalating conflicts with elephants in the north-west, particularly in the Kamanjab commercial farming area but also, to a lesser extent, in the communal lands.

The study focuses on the elephants of Kunene Region, including Etosha National Park, Skeleton Coast National Park, the communal land (Conservancies, Concessions and the remaining communal land not falling into these categories) and the private land farming area south of Etosha. These elephants are unique in Africa in that they have unrestricted access to a range of over 100,000km<sup>2</sup>. The problems require to be addressed at the scale of a very large landscape.

Despite the impression of unlimited space, the north-west is an arid environment which has a low carrying capacity for both humans and elephants. Elephants numbers are increasing outside the national park through their own breeding and presumed emigration from Etosha. The available range outside the national park is shrinking as the number of humans and domestic livestock increases. Elephants are competing with livestock for living space, food and water. The result is that the elephants are being forced to seek these resources in the commercial farming area.

**We are dealing with an elephant population *in extremis*** – living in a regime of resource shortages, being harried from pillar to post and causing inadvertent havoc in their wake.

A simulation model has been used in an attempt to understand the dynamics of people and elephants in Kunene Region. The model involves both people and elephants in a geographic situation with assumed population growth rates and carrying capacities for both people and elephants. Based on the land requirements for people and their livestock, the amount of land available for elephants is calculated each year from 1995-2020 and this decides the elephant movements within the Region. The model fits the known facts about the elephant population and accounts for the elephant surpluses which have been appearing in the commercial farming areas since 1997.

With no management interventions, the total elephant population in Kunene Region is predicted to rise to about 3,250 animals in 2020, of which 2,400 will be in Etosha National Park and 850 will be in the rest of the Region.

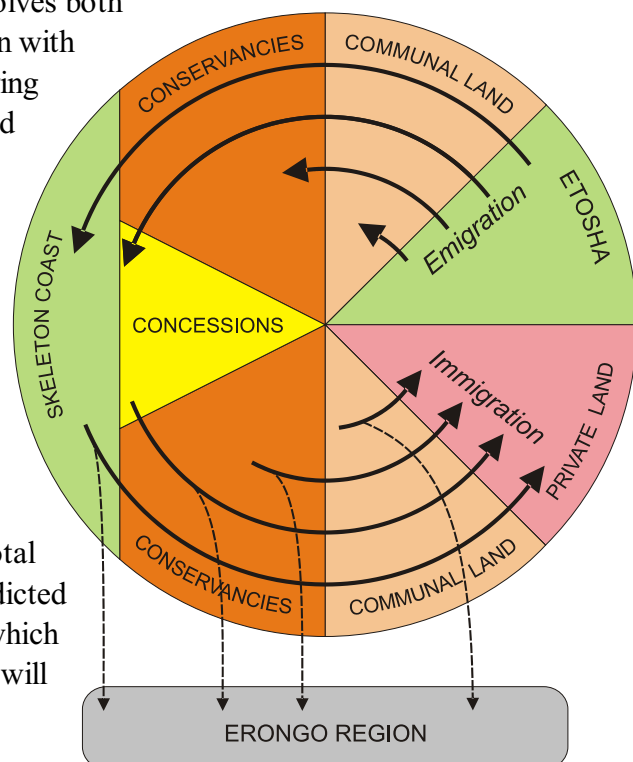

**Kunene Region simulation model**



In the year 2020 the Etosha population is some 400 animals above its assumed carrying capacity and about 80 elephants emigrate annually into the rest of the north-west Region. Skeleton Coast and the communal land concessions have a low carrying capacity (about 133 animals). The population in these areas builds up from 121 animals in 1995, exceeds carrying capacity in 1996 and ends up being nearly three times greater than carrying capacity in 2020 (360 animals).

The communal lands carrying capacity declines from some 500 animals in 1995, when the elephant population is just below carrying capacity, to under 200 animals in the year 2020. The elephant population increases from 400 animals in 1995 to just over 500 animals by the year 2020 (300 elephants more than the assumed carrying capacity). At this stage, despite the assumed immigration from Etosha, the population is more or less constant as animals emigrate from the communal lands into Erongo Region and the commercial farming areas in Kunene Region.

By the year 2020 the entire area outside Etosha is acting simply as a ‘throughput’ system. The animals immigrating from Etosha together with the annual population increment resulting from breeding in the north-west is being ‘exported’ in the same year. The model predicts that the total emigration from the north-west will be about 100 elephants per year in 2020 with half of these animals entering the commercial farming areas in Kunene Region and the other half entering Erongo Region.

A second elephant population model examined the effects of various management options for the Kunene Region. Five scenarios were analysed –

Scenario 0. No Management

Scenario 1. No Management except for elephant trophy hunting in the north-west.

Scenario 2. Cull elephants in Etosha National Park to keep the park population below carrying capacity. Trophy hunting continues outside the park.

Scenario 3. Cull elephants outside Etosha National Park to keep the north-west elephant population below carrying capacity. Trophy hunting continues outside the park.

Scenario 4. Cull elephants both in Etosha National Park and in the remainder of the Kunene Region to keep both subpopulations below carrying capacity. Trophy hunting continues outside the park.

The long-term implications of these scenarios for population numbers, emigration and trophy hunting quotas are summarised in the table below –

### Long-term Results of Management

Scenario	ELEPHANT NUMBERS			EMIGRATION		NW Hunting Quota
	Kunene Region	Etosha NP	North-West	from Etosha	from North-West	
0	3,300	2,400	900	80	100	0
1	3,300	2,400	900	80	100	6
2	2,300	1,900	400	0	10	3
3	2,700	2,400	300	80	0	17
4	2,200	1,900	300	0	0	3

The required culling offtakes under Scenarios 2, 3 and 4 are given in the table below. In each case there is a high initial offtake intended to bring the population down to its carrying capacity in one year followed by a long-term maintenance offtake which will keep the population at carrying capacity.

**Population reduction – culling offtakes**

Scenario	INITIAL CULL 2010		MAINTENANCE CULL	
	Etosha NP	North-West	Etosha NP	North-West
2	480	0	40	0
3	0	560	0	70
4	480	500	40	10

These results are intended only to be indicative of the magnitude of elephant numbers which might be required to be removed from the population according to the population model. **It is not recommended that the culling be implemented in this manner.**

The financial implications of this management are shown in **Table 5** (page 27 in the report). Whichever management option is pursued, the net income from management should exceed US\$0.5 million (N\$4 million) per year. The highest net income of US\$0.9 million (N\$7.2 million) arises from Scenario 3 (culling outside Etosha national park).

The financial implications of destroying all elephants entering the Kamanjab farming area under Scenarios 0 and 1 (previous page) have also been estimated. The commodity values (meat, skin and ivory) should produce about N\$2.6 annually. The hypothetical scenario that all elephants survive and breed in the Kamanjab farming area produces a net annual income of about N\$11 million from trophy hunting, culling to keep the population within the theoretical carrying capacity, and ivory arising from natural mortality.

All of these financial estimates have been made using the real market values for ivory – which may not be realisable under present CITES constraints on the ivory trade. It is strongly recommended in the report (**Appendix 9**, page 64) that **Namibia should re-examine its position in relation to CITES.**

The predicted culling offtakes appear very high. Alternatives to culling have been examined in the Discussion section of the report (page 350) but the conclusion is that, with one possible exception, none provide answers to the problem. The exception is discussed below.

Both in the communal land conservancies and in the commercial farming areas there are no indications that land use practices or farmers' lifestyles are changing – notwithstanding the fact that the body of evidence suggests that, as a primary land use, wildlife management is highly profitable particularly in areas of low and variable rainfall. This is a direct result of government's reluctance to devolve sufficient authority to landholders to carry out their own management of wildlife. The rights a farmer enjoys over wildlife, either in a communal land conservancy or on private land, should be no different to those he/she enjoys over cattle.

## RECOMMENDATIONS

No elephant population can expand indefinitely. There is nothing ‘natural’ about an elephant population which has been expanding in the north-west and Etosha National Park since the 1980s with very low levels of illegal hunting and no management interventions. Cumming (2007) presented evidence to show that elephant numbers have been regulated (controlled) by humans for the past one million years. Man has always been the super-predator for elephants. We are now dealing with an unnatural situation where elephants in Kunene Region have exceeded their carrying capacity.

There are some short-term measures which could relieve the situation. They will not necessarily solve the problem in the long term.

### 1. Short-term measures

- (1) The provision of water for elephants along the boundary between the communal lands and commercial farming area in Kunene Region might limit the incursions into private land.
- (2) The adoption of a ‘Source- Sink’ management system within the Region (**Fig.14**, page 39) will address the immediate crisis. One such ‘sink’ would be located in the Kamanjab farming area where all elephants entering the defined area are destroyed. Several other sinks would be created in the communal lands in areas of high population density for humans, livestock and elephants.

This adaptive management system provides a means of avoiding large culls. Elephants would be removed from sink areas over a period of years until there are no further incursions into the commercial farming area and those parts of the communal lands where they are not wanted.

The management should not be carried out by MET for several reasons: firstly, it would be a major drain on government resources because the task would require a full-time, on-the-ground presence of problem animal control staff; secondly, whatever these staff do it will be unlikely to satisfy the farmers completely; thirdly, if the responsibility is placed completely with the farmers, they will have no grounds for any further complaints; and, lastly, if they are given the responsibility it is likely that they will find a solution which does not necessarily result in the deaths of all elephants entering the sink areas.

Such a system must go hand-in-hand with institutional development in the commercial farming area and communal land conservancies –

- a. Conditional on government granting the farmers a mandate to handle the problem themselves, must be the submission of a plan by the farmers that provides the assurance that the system will be administered impartially and that the benefits from the elephants will accrue to all the affected farmers;
- b. The farmers must be given the full latitude to make best use of the elephants. This should include selling trophy bulls (but not females) when the opportunity arises. It should also include the right to translocate elephants if circumstances are favourable.
- c. All of the benefits from the population reductions (including ivory) should belong to the relevant conservancies or commercial farmers.

- 
- (3) The question of whether the elephant population in Etosha National Park should be reduced should depend upon the outcome of the proposed source-sink management measures recommended for the north-west communal lands and the commercial farming areas. If these do not solve the present human-wildlife conflict, then the elephant population in the Park must come under scrutiny.

This study has estimated the culling offtake needed to bring the Etosha elephant population down to a notional carrying capacity but, given the variability of rainfall, the carrying capacity cannot be stated with any certainty. According to the simulation model used in this study, if there is emigration from Etosha, then a reduction in the Etosha elephant population will have a marked effect on the incursions of elephants into the commercial farming area.

In the present circumstances it may be difficult to diagnose whether the Etosha elephant population has exceeded carrying capacity. However, a reduction in the population carries lower risks than the alternative of no management. If the Etosha elephants are above carrying capacity, a reduction in their numbers will be beneficial for the habitats in the park and will reduce inter-specific competition. If culling in Etosha reduces the incursions of elephants into the commercial farming area, a question will have been answered. Nothing will be learnt about the status of the elephant population under the 'No Management' scenario.

Were government to take such an approach, the results might end up surprising all stakeholders. Long before the full complement of elephants predicted under this study has been removed from the population, it is highly likely that the stakeholders will have found other solutions to the problem or modified the programme to produce greater benefits. But for this to work requires that they are given the authority to experiment with the programme. The outcome could easily be that a greater range is created for elephants in the north-west by communities agreeing amongst themselves on a zoning system for livestock and elephants.

---

## 2. Longer term options

- (1) Institutional development – Were government to adopt the recommendations above, it would go a long way towards addressing the problem.
- (2) Intervention in land use

The problem in the commercial farming area of Kunene Region could be seen as lying in the geographic juxtaposition of two radically different forms of land use. Immediately adjacent to the major national park in Namibia is a farming area pursuing conventional domestic livestock farming.

The Namibian government has the option of making a drastic intervention in the area south of Etosha National Park. The State could expropriate all of the farms as was done in the Matetsi Area of Zimbabwe in 1970 (page 42).

**This study is not advocating such an action and, were it to be done, would not recommend that the land became State Land.** It could remain private land with a servitude imposed on the title deeds so that the land could only be used for wildlife management. Full compensation would need to be paid to farmers who chose not to remain. And to ensure that future wildlife regimes on the land were profitable, the transition would need to be accompanied by enabling provisions in the legislation which granted authority over wildlife and provided incentives for the amalgamation of farms into major conservancies managed at suitable scales.

The ultimate aim of achieving improved land use and contributing significantly to the Namibian economy might be achievable without such drastic action simply by amending the present legislation to provide the enabling conditions. The resulting outcome might be even better and more robust because it would have been built upon choice by the landholders themselves.

---

## INTRODUCTION

Martin (2004a) prepared the Elephant Management Plan for Namibia which was adopted by the Ministry of Environment and Tourism in 2007. The Goal and Objectives for elephants in that plan were –

### GOAL

Namibia wishes to carry the maximum number of elephants consistent with the conservation of biological diversity AND the wishes of those primary stakeholders who have elephants on their land

### SOCIAL OBJECTIVE

1. To reduce conflict between elephants and people
2. To create conditions under which elephants are a benefit to people

### ECOLOGICAL OBJECTIVE

1. To increase the range available to elephant
2. To conserve biological diversity in State Protected Areas and promote the conservation of habitats outside State Protected Areas in the elephant range

### ECONOMIC OBJECTIVE

To enable the full economic potential of elephants to be realised according to the provisions for sustainable use in Namibia's Constitution

The present elephant problem in the north-west of Namibia has not altered these objectives.

---

In 2004, the Etosha National Park elephant population was between 2,000-2,500 elephants and the north-west population outside the park was about 800 animals.

At that time I observed that the elephant population outside Etosha had been increasing steadily since 1990 and that the elephant range was increasing. I noted that there was some conflict with elephants in the communal lands north of Etosha but felt that, because human populations west of Etosha were relatively sparse and most of the land between Etosha and the Skeleton Coast was organised into conservancies, elephant numbers could continue to increase and the elephant range would be able to expand southwards and into the extreme north-west along the Kunene River. I did not foresee that elephants would become a problem in the north-west so soon and was unaware that there were already problems with elephants in the commercial farming areas south of Etosha.

In recent years, conflict with elephants has escalated in the farming districts surrounding the western half of Etosha National Park, extending southwards through Kamanjab to Outjo and towards Otjiwarongo. Although the Kamanjab farmers are in the vanguard on this conflict, to a lesser or greater extent the same problems are also affecting emergent farmers in the commercial farming area, the communal land conservancies and other communal land.

Lindeque (1988) asserted that the Etosha elephant population should be seen as part of the larger population occurring through north-west Namibia. The rate of growth of the elephant population outside the park (some 6% per annum) suggests that the population is being augmented by a net emigration from within the park. Thus any examination of the north-west elephants **must take into account the population within the park.**

A population of less than one thousand elephants distributed over 100,000km<sup>2</sup> in the north-west of Namibia is not a lot of animals. The stocking rate is less than one elephant to 100km<sup>2</sup>. However, the steep gradient in declining rainfall from east to west results in a range which is most attractive to elephants south and east of Etosha – mainly in the commercial farming districts. Whilst there is a certain romance attached to the presence of elephants in the extreme desert areas west and north-west of the park, it is unlikely that this area will be able to support many more elephants than are there at present due to the extreme aridity, the increasing human populations and the increasing numbers of livestock. Thus **the human-elephant conflict in the farming districts south of Etosha is not going to be solved by attempting to redistribute elephants within the range – it will have to be solved *in situ*.**

The problems arising from elephants in the north-west are not simply explained by the notion that elephants have exceeded some technical carrying capacity. They are also due to the prevailing land use systems and chosen farming lifestyles. Nevertheless, some farmers have called for ‘scientific studies’ to assess the carrying capacity for elephants<sup>2</sup> and this report takes up the challenge.

The mix of human factors, economic factors and ecological factors which affect the management of elephants in the north-west make this a **complex system** (Holling 2001). Complex systems are not amenable to quick solutions provided by reductionist science and they produce surprises which are impossible to predict. Ultimately, the solutions to the problems of the north-west elephants will have to come from the innovation of the people living in the north-west – they will not come from externally designed management plans or centrally implemented blueprints. The rôle of government is to release the creative capabilities which the stakeholders in the north-west could bring to the table. And this requires institutional change consistent with the new Human-Wildlife Policy (MET 2009).

Martin (2004b) emphasised the institutional changes that need to be made if elephants were to realise their full ecological and economic potential in Namibia. The present classification of elephants as *Specially Protected Game* under Namibian law is not contributing to their conservation. The original justification for such a listing has disappeared. **To achieve the objectives of a Management Plan for the north-west elephants, the legal provisions for elephants should be re-examined.**

---

2. The Otjikondo Farmers’ Union called for a study to assess the carrying capacity for elephants at workshop held in Grootberg in 1999 (OFU 1999).

**Significant devolution of rights over elephants to landholders** (on both communal and private land) is a prerequisite for creating the incentives to allow elephant populations to survive in significant numbers outside Etosha and to realise their full potential in economic development.<sup>3</sup> It is a necessary but not a sufficient condition. In the unique situation of an elephant population which has unrestricted access to over 100,000km<sup>2</sup>, **co-management between the State and relevant landholders will be necessary to achieve effective management at the scale of a very large landscape.**

Finally, the north-west elephant population needs to be seen in a larger context. Throughout southern Africa elephant populations are ‘unnaturally’ high. Cumming (2007) presented evidence to show that elephant numbers have been regulated (controlled) by humans for the past one million years. Man has always been the super-predator for elephants. There is nothing ‘natural’ about an unmanaged elephant population in a large national park – it is missing its primary predator. The ecological consequences of an overpopulation in such a park are beginning to be understood: a great deal has yet to be learned about the socio-economic consequences of too many large proboscideans in a human landscape.

---

3. The new HWC Policy (MET 2009, page1) states that, “In order to achieve this, Government will delegate decision-making to the lowest appropriate institutional levels ...”.



## A STATEMENT OF THE PROBLEM

A field trip was made to the Kamanjab farming area and neighbouring communal land farms in November/December 2008. It is owed to the farmers who so kindly hosted me on this visit to document the effects which elephants are having on their farming operations.

### Direct damage caused by elephants

- (1) Dangers to human life (including school children),<sup>4</sup> particularly from wounded elephants<sup>5</sup>
- (2) Injuries and deaths of livestock<sup>4, 14</sup>
- (3) Damage to cattle fences, kraals and gates<sup>6</sup> with numerous consequences including –
  - a. Disruption of breeding programmes for cattle held in paddocks ('camps')<sup>6, 8</sup> which, in the extreme case, has forced farmers to abandon the system of camps<sup>7</sup>
  - b. Disruption of water management, pasture management and cattle selection practices<sup>8</sup>
  - c. Intermingling of cattle with those of neighbouring properties – which can take months to sort out<sup>5</sup>
  - d. Cattle straying onto main roads – danger to vehicles particularly at night placing the farmer in a position where he can be sued<sup>6, 14</sup>
  - e. Theft of cattle when fence breakages occur along the boundary with communal lands<sup>7</sup> or on main roads<sup>14</sup>
  - f. High costs of fence repair<sup>6, 14</sup>
- (4) Damage to water installations including watertanks,<sup>4</sup> drinking troughs (cripps), ballvalves<sup>11</sup>
- (5) Damage to vegetation<sup>9</sup>
- (6) Competition with cattle for forage<sup>9</sup>
- (7) Destruction of vegetable gardens<sup>14</sup> and chilli plants<sup>10</sup>
- (8) Damage to game fences<sup>11</sup>
- (9) Losses of wildlife to other properties, which is particularly onerous when this consists of premier species which have been introduced at a high price<sup>11</sup>

The estimates of the damage costs to the individual farmer due to elephants in the Kamanjab farming area range from N\$40,000-90,000 annually.<sup>11, 5</sup> Unfortunately there is a perception that wildlife farms are not maintaining their fences and that the bulk of the costs falls on cattle farmers.<sup>7</sup>

- 
4. Farms Emmanuel (613), Condor (617) and Grootberg (191) in ≠Khoadi -//Hoas Conservancy
  5. Willie Gundeling (Lusthof 243)
  6. Japie Avis (Hohenfelde 41)
  7. Frankie Robbertse (Vryheid 267)
  8. Kamanjab Bouvereeniging (2001)
  9. OFU (1999)
  10. Dr E.E. Kesslau (Blydskap 268) had 800 chilli plants eaten by elephants.
  11. Dr E.E. Kesslau (Blydskap 268). Derives main farm income from wildlife. Has lost over 100 oryx, 100 zebra and 50 springbok to fence breakages by elephants. Reluctant to make further investments in stocking with wildlife.

## Relationships with Government

There is strong resentment amongst both the communal land farmers and private land farmers over the failed attempts to communicate with Government – which they perceive as a long history of broken Government promises.<sup>12, 9</sup> There is a sense of powerlessness and a lack of faith in MET's capability to respond to elephant problems.<sup>13</sup> In their frustration, the farmers have turned to the NAU.<sup>6</sup>

The present benefits which farmers are receiving from elephants on their land do not come close to compensating them for their losses.<sup>5</sup> Farmers are not free to defend their livelihoods from elephant depredations and the current arrangements for control of problem elephants are too tardy to be effective.<sup>13</sup> **A result of this is the inception of illegal hunting by dissatisfied people.**<sup>14</sup>

## Monitoring

This study was hampered by the lack of data available on elephant incursions and incidents in the commercial farming area. The Complaints Register held by MET staff in Outjo records 24 incidents between 25 January 2006 and 2 July 2008 and most of reports originate from a few individuals. There are no further records. The fault does not necessarily lie with the MET staff but the absence of records suggest a lack of confidence amongst the farmers that elephant incidents are worth reporting. It might reasonably have been expected that the farmers themselves would have kept a meticulous record of elephant incidents and consolidated the record into an overall report which would have greatly strengthened their hand with MET.

## Overall Assessment

For the purpose of the analysis which follows it has been assumed that Etosha National Park is generating a surplus of elephants and some are moving into the communal lands. Elephants are increasing in numbers outside the national park through their own breeding and the immigration from Etosha. The available range outside the national park is shrinking as humans increase in numbers and livestock holdings – competing with elephants for living space, food and water in an arid environment which, despite the apparent wide open spaces, has a low carrying capacity for both humans and elephants.

Water points have been protected in the communal lands to prevent elephants damaging them and to ensure an adequate supply for people and their livestock. The flow of key rivers in the communal lands (Huab, Ugab, Omaruru) has been reduced by the construction of upstream dams in the commercial farming areas.<sup>13</sup> The elephant 'invasions' of the Kamanjab farming area are the culmination of a search for food and water.

All of symptoms point to a 'very unhappy elephant population' living in a regime of shortages, being harried from pillar to post and causing inadvertent havoc in their wake.

---

12. John van der Westhuizen (Westfalen 245)

13. Fox & Berry (1999)

14. OFU (1997)

## ANALYSIS

This main part of report leads to two population models. The first model attempts to simulate the population dynamics of elephants in the Kunene Region over a number of years, taking into account the changing amount of land available to them, the expected augmentation of their numbers through immigration from Etosha National Park and their expected emigration from the communal lands into private farming land as they reach carrying capacity. The second model examines the response of the elephant population to various management treatments and presents the costs and expected financial returns from the management.

### 1. The North-West Study Area

The Kunene Region has been selected as the study area<sup>15</sup> since it includes most of the north-west elephant population. The study area extends from the Ugab River in the south to the Kunene River in the north and includes the major part of the commercial farming area currently affected by elephants. A land tenure map of the Region (**Fig.1**) is shown below.

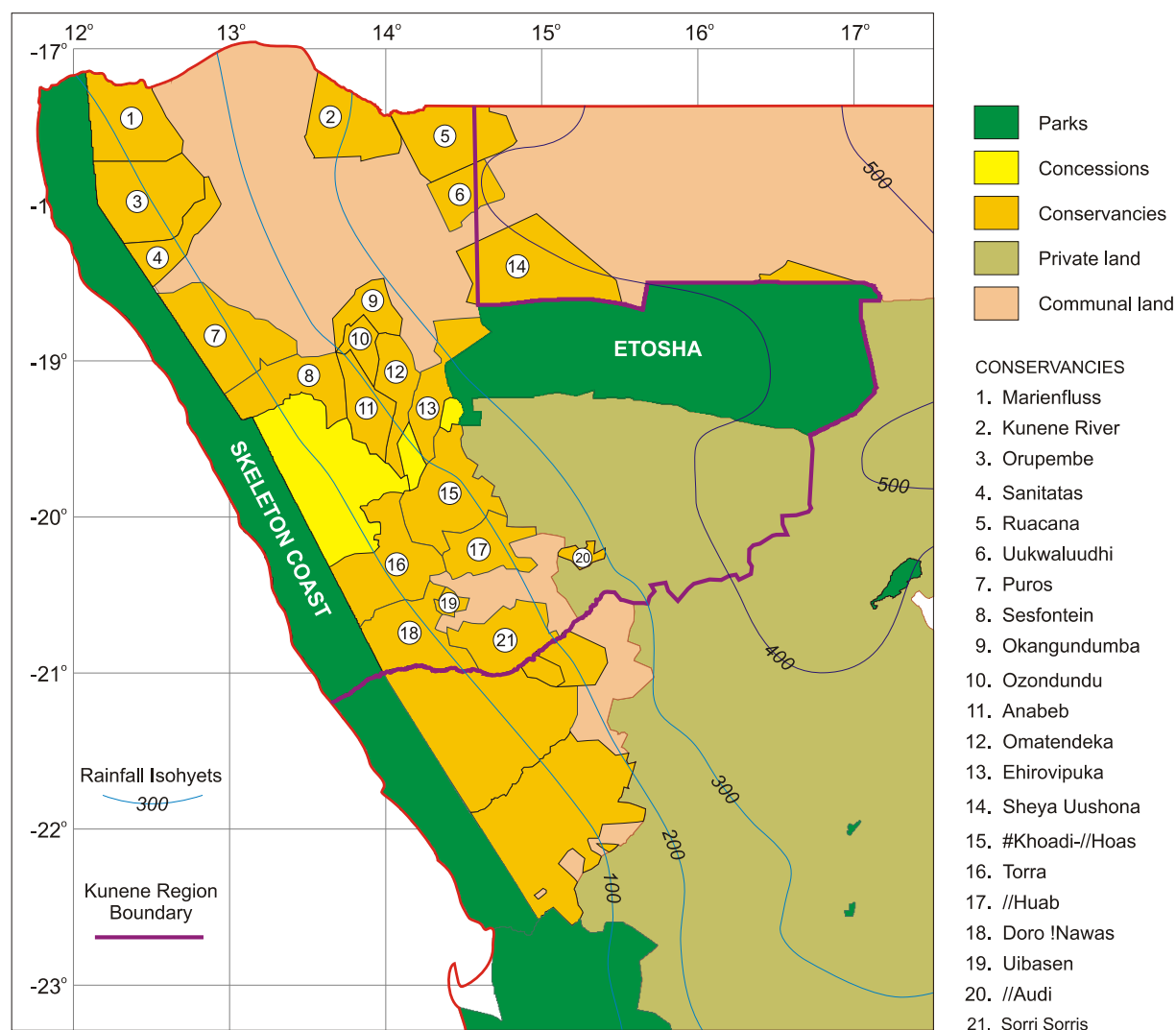

**Figure 1: Kunene Region land categories**

15. The Kunene Region boundary shown in Fig.1 was altered in 2009. It does not affect the analysis.

It does not include all of the north-west elephants: there are a number south of the Ugab River (perhaps fewer than 100) extending at least as far south as the Omaruru River. These elephants are appearing the Omaruru and Kalkveld farming districts. There are also small numbers of elephants north of Etosha and east of the Kunene Region boundary foraging as far north as Etunda and Tsandi (east of Ruacana).

Areas have been calculated for all the land tenure categories in Kunene Region (**Table 1** below). The areas of all the individual conservancies are given in **Table 3** (page 11).

**Table 1: Kunene Region areas in various land categories**

LAND CATEGORY	SPECIFIC AREAS	TOTAL AREA (km <sup>2</sup> )
PARKS	Etosha National Park	22,270
	Skeleton Coast National Park	16,390
COMMUNAL LAND	Concessions	7,775
	Conservancies	49,193
	Other communal land	30,085
PRIVATE LAND	Kamanjab, Otjikondo, Outjo	24,562
		150,275

#### Notes

The study area extends slightly outside Kunene Region through the inclusion of an additional 5,199km<sup>2</sup> being the portions of Ruacana Conservancy (425km<sup>2</sup>), Uukwaluudhi Conservancy (444km<sup>2</sup>) and Sheya Uushona (4,541km<sup>2</sup>) lying east of the regional boundary.

The conservancies referred to in the table are those listed in NACSO (2008). I am aware that since this publication most of the 'other communal land' in the table has now been registered as conservancies (Gary Nekongo, CBNRM Warden, Opuwo, *pers.comm.*).

Because of the importance of rainfall in determining the carrying capacities both for elephants and people in Kunene Region (next main section), the areas falling between the rainfall isohyets shown in Fig.1 are given in **Table 2** below.

**Table 2: Proportions of Kunene Region in rainfall isohyets**

Annual Rainfall	0-100mm	100-200mm	200-300mm	300-400mm	400-500mm
Area (km <sup>2</sup> )	30,103	31,860	28,455	39,672	14,502
% of Area	21	22	20	27	10

Some 63% of the total area of the Region has less than 300mm of rainfall annually indicating very low carrying capacities for both people and elephants.

## 2. The Elephant Population

Owen-Smith (1970) estimated the elephant population in the Kaokoveld at 700-800 animals. In the years which followed (1972-1982) heavy illegal hunting reduced these numbers to as few as 50 (Rudi Loutit *pers. comm.*, G. Owen-Smith *pers. comm.*, Viljoen 1988). The appointment of the first Nature Conservator in the area in 1981 (Chris Eyre) largely put an end to the illegal hunting and trade. In 1982, forty cases were taken to court of which 39 resulted in convictions. Elephant numbers have been increasing in the north-west since that time. Martin (2004a) estimated the population at about 800 animals.

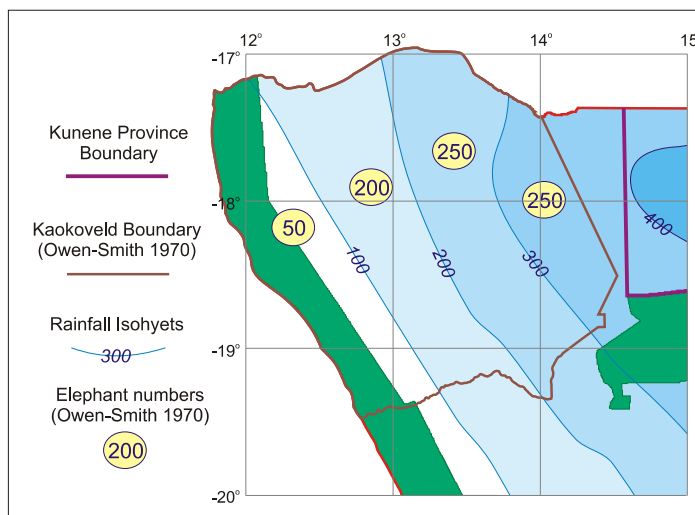

**Figure 2: Elephant numbers in the Kaokoveld in 1970**

Owen-Smith's detailed assessment of elephant numbers and distribution in the Kaokoveld in 1970 (**Fig.2** above) is not merely of historic interest. If it is assumed that elephants were close to carrying capacity in the Kaokoveld in 1970, it allows some estimate of the relationship between rainfall and carrying capacity for the arid conditions of the north-west (next subsection).

There is a paucity of recent estimates of the numbers of elephant in the Kunene Region. Gibson (2001) reviewed the reliable and comparable surveys from 1982-2000 (which included that of Viljoen (1982 and various MET surveys) and gives the graph shown in **Fig.3** opposite. Between 1982 and 1998 the elephant counts showed a statistically significant consistent increase of 6.2% per annum in the population (between 3.5% and 9%). Since this exceeds the expected growth rates for elephant populations (Martin 2004a) it seems very likely that immigration from Etosha has supplemented the population numbers.

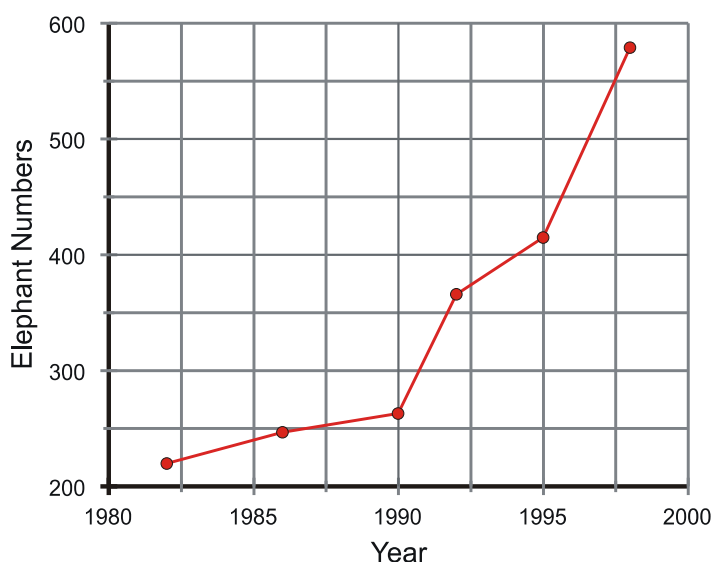

**Figure 3: North-west elephants – Survey data 1998-2000**

Gibson's data are important for the modelling in this study because (a) they provide estimates in the years 1995-2000 which allow the setting of the initial population values and (b) they provide growth rates which allow the setting of numbers migrating from Etosha at that time.

Martin (2004a) reviewed the elephant survey data for Etosha National Park and modelled the population in an attempt to resolve the relationship between numbers, mortality, immigration and emigration over the period 1971-2004.

The model results indicated that the population increased rapidly between 1971 and 1983 to its highest recorded level of 2,800 animals – mainly as a result of immigration although the mortality between 1971 and 1979 was lower than expected. This period coincided with a heavy hunting pressure outside the park and with a surplus in the cumulative rainfall. In 1980 mortality shifted to being higher than expected (mainly as a result of anthrax) but this negative effect was not sufficient to stop population increase. After 1983 the population declined sharply due to a combination of factors of which the emigration of almost 1,000 animals in 1985 had the greatest effect. Two culling operations removed 570 animals from the population and mortality remained higher than expected up until 1990. In 1983, the cumulative rainfall switched to a deficit mode and the illegal hunting pressure outside the park was greatly reduced. These two factors may have resulted in the 1985 emigration referred to above.

Apart from a brief increase to a level of 2,000 animals in 1987 caused by the presumed immigration of some 600 animals, the population declined to 1,188 animals in 1995. The mortality during this period was not sufficient to have caused the decline and it must be attributed to a sequence of small emigrations between 1988 and 1995, none of which were statistically significant in isolation but which in concert reduced the population by some 800 animals.

After 1995 the population increased – again at a rate exceeding the intrinsic growth rate. Although this coincided with a period of lower than expected mortality, the increase must be attributed to immigration from 1996-1998. From 1999-2004 the population fluctuated around 2,300 animals. A recent communication (Werner Kilian, *pers.comm.* March 2009) suggests that the population is still between 2,000-2,500 animals. In the simulation model which follows, the Etosha population has been set at 2,000 animals in 1995.

Recognising the fairly wide confidence limits on surveys, it is nevertheless surprising to find no inverse relationship between estimates in years when surveys were carried out both inside and outside the park. It might be expected that in years when Etosha showed a relatively ‘low’ population a higher than usual estimate would be obtained outside the park.

---

There are few, if any, survey records of elephant numbers on the commercial farms south of Etosha. The inception of significant elephant incursions into the Kamanjab farming area began in 1997-98 (Japie Avis [*Hohenfelde*], Frankie Robbertse [*Vryheid*], Karel Kruger [*Bruno*], *pers.comm.* November 2008). For the modelling process which follows, these are important dates because the assumption is made that this coincides with elephants exceeding the carrying capacity of the adjacent communal lands.

Notwithstanding the limited data for the north-west as a whole, sufficient information exists to provide the key benchmarks needed to construct a plausible model of the expected population dynamics of elephants in the Kunene Region.

---

### 3. Carrying Capacities and Population Growth Rates

#### (1) Elephants

The relationships used in the simulation model for the carrying capacity and rate of growth of elephant populations in relation to rainfall are shown in **Fig.4** below.

The formulae used are –

**Stocking level (km<sup>2</sup>/elephant)**

$$SL = 4.5 + 459 e^{-0.0125 \text{ Rainfall}}$$

**Population rate of growth (%/yr)**

$$RG = 1 + 0.0066 \cdot \text{Annual Rainfall (mm)}$$

The stocking level is based on the assumption that the present Etosha population is close to carrying capacity (2,000 elephants in 18,000km<sup>2</sup> in an area with an average annual rainfall of about 350mm). The areas at the lower end of the rainfall range are based loosely on Owen-Smith (1970).

Martin (2004a) estimated that the Etosha population had an intrinsic growth rate of 3.3%. At rainfall levels above 500mm year elephant populations with stable age structures grow at about 4.5% per annum. The values at the lower end of the rainfall range shown in Fig.2 are simply a linear extrapolation from these two values.

It is of interest to speculate how many elephants the Kunene Region could carry if there were no people in the communal lands and the entire commercial farming area were available to elephants. Using the formula for elephant stocking levels developed above, an estimate has been made in **Table 3** on the next page. In a total of **150,000km<sup>2</sup>** the elephant population might be **7,500** animals.

Excluding the commercial farming area, the potential number of elephants is reduced to some **5,200**. Further, excluding Etosha, the apparent potential for elephants is **3,300**. Finally, excluding all areas with more than 300mm of rainfall,<sup>16</sup> the potential population in the arid north-west is **1,300** elephants.

*But all this assumes there are no people in the communal lands.* In the next subsection (page 12), the relationship between numbers of people and potential elephant numbers is explored.

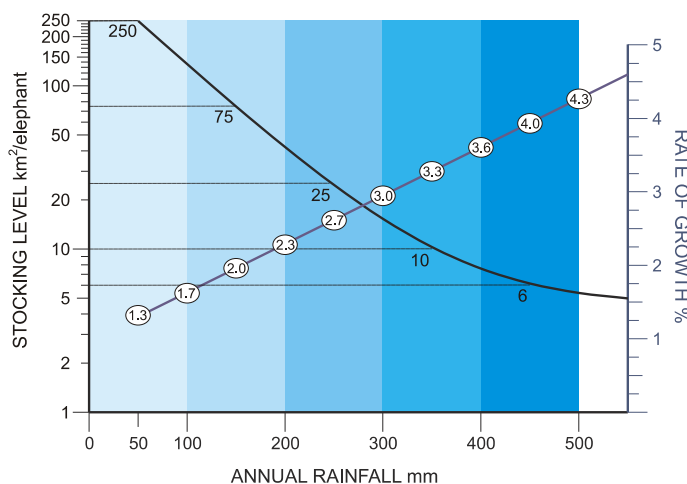

**Figure 4: Elephant stocking level and rate of growth in relation to rainfall**

16. The areas of communal land above 300mm of rainfall are heavily settled with little potential for elephants.

**Table 3: Potential elephant population in Kunene Region without people**

<b>Conservancies</b>		Area km <sup>2</sup>	Rain mm	Model km <sup>2</sup> /ele	Number of elephants	Rain <300mm
1	Marienfluss	3,034	120	106.9	28	28
2	Kunene River	2,764	310	14.0	197	
3	Orupembe	3,565	100	136.0	26	26
4	Sanitatas	1,446	110	120.6	12	12
5	Ruacana	2,993	360	9.6	312	
6	Uukwaluudhi	1,437	400	7.6	189	
7	Puros	3,568	90	153.5	23	23
8	Sesfontein	2,591	110	120.6	21	21
9	Okangundumba	1,131	260	22.3	51	51
10	Ozondundu	745	230	30.4	25	25
11	Anabeb	1,570	180	52.9	30	30
12	Omatendeka	1,619	200	42.2	38	38
13	Ehrovipuka	1,975	250	24.7	80	80
14	Sheya Uushona	5,066	380	8.5	598	
15	≠Khoadi-//Hoas	3,366	170	59.3	57	57
16	Torra	3,522	100	136.0	26	26
17	//Huab	1,817	200	42.2	43	43
18	Doro !Nawas	4,073	80	173.4	23	23
19	Uibasen	286	130	94.9	3	3
20	//Audi	335	270	20.2	17	17
21	Sorri Sorris	2,290	150	74.9	31	31
<b>Subtotal</b>		<b>49,193</b>			<b>1,830</b>	<b>534</b>
<b>Other Communal Land</b>						
	Rainfall <100mm	393	50	250.2	2	2
	Rainfall 100-200mm	9,812	150	74.9	131	131
	Rainfall 200-300mm	12,970	250	24.7	526	526
	Rainfall 300-400mm	6,909	350	10.3	672	
<b>Subtotal</b>		<b>30,085</b>			<b>1,331</b>	<b>658</b>
<b>Concessions</b>						
	Skeleton Coast	16,390	50	250.2	66	66
	Palmwag	6,398	85	163.1	39	39
	Etendeka	1,108	160	66.6	17	17
	Hobatere	269	260	22.3	12	12
<b>Subtotal</b>		<b>24,165</b>			<b>133</b>	<b>133</b>
<b>Etosha</b>						
	Etosha West	9,479	330	11.9	795	
	Etosha East	8,521	400	7.6	1,122	
<b>Subtotal</b>		<b>18,000</b>			<b>1,918</b>	
<b>Private Land</b>						
	Rainfall 200-300mm	5,861	250	24.7	238	238
	Rainfall 300-400mm	12,650	350	10.3	1,231	
	Rainfall 400-500mm	6,050	450	6.2	983	
<b>Subtotal</b>		<b>24,562</b>			<b>2,451</b>	<b>238</b>
<b>TOTALS</b>		<b>146,005</b>			<b>7,663</b>	<b>1,564</b>



**(2) People**

The relationship between rainfall and carrying capacities for people is more problematic. The amount of land required per person in the arid conditions of Kunene Region is very much dependent on the numbers of livestock which each household owns. Craig (2001) examined the distribution of wildlife and livestock in the region from aerial surveys in 1988 and 2000 (**Fig.5**).

The results demonstrate the avoidance by wildlife of areas where livestock densities are high. Elephant are effectively competing with domestic livestock for forage.

As the numbers of people and livestock increase in the Kunene Region, the range available to elephant will shrink and must inevitably give rise to their dispersal from communal land. Various methods of defining the relationship are discussed in **Appendix 1** (page 43). The relationship used in the model is shown in **Fig.6** below.

Also shown in Fig.6 is the average land requirement per person across the rainfall range from 0-500mm. This is effectively the carrying capacity for any given area. By multiplying the number of people in the area by the land requirement per person for the particular rainfall category, the amount of land left over for elephant can be calculated.

According to this scenario, in the year 2007 only 7 out of the 21 conservancies were below the line defining the relationship, i.e. they still had surplus land available to accommodate elephants. When the human population is extrapolated back to the year 1995 taking into account the population growth rate, more than half of the conservancies (12) had space available for elephant.

Namibia's rate of human population growth has slowed markedly in the past few years. HINNAM (2008) estimates the national average at under 2% per annum. I have used a rate of 2.5% for the people in Kunene Region on the basis that the major reductions in the growth rate have taken place in the urban areas rather than amongst rural people.

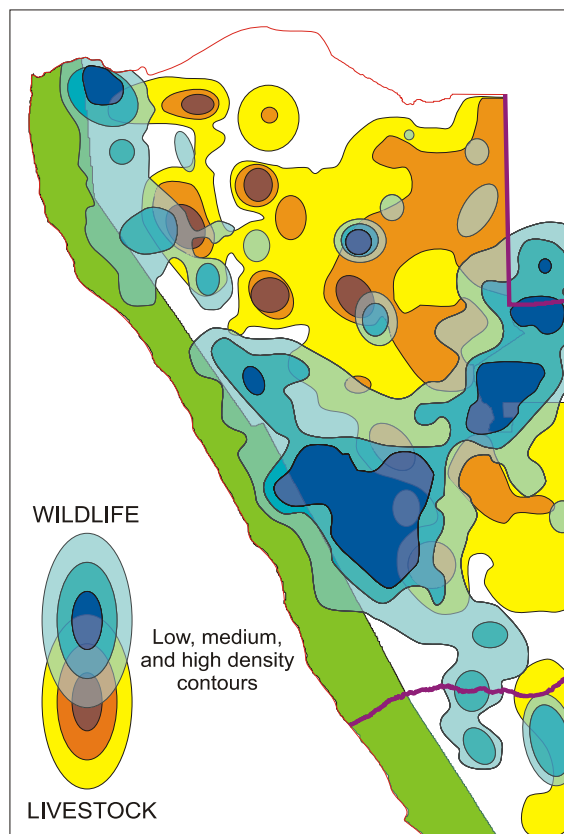

**Figure 5: Distribution of wildlife and livestock in Kunene Region in 2000**

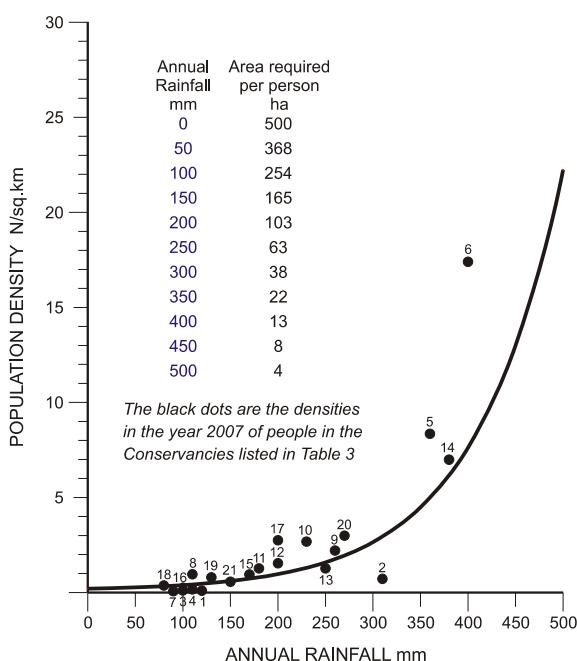

**Figure 6: Carrying capacity for people**

Within Kunene Region the available range for elephants is shrinking. This is taking place only in the communal lands – the range available in Etosha and Skeleton Coast National Parks and the communal land concessions is staying more or less constant.

The numbers of people in the communal land have increased from some 140,000 in 1995 to about 200,000 at the time of writing and their numbers can be expected to reach 260,000 by the year 2020 (Fig.7). In the same period, according to the relationships developed in Appendix 1, the land available for elephants has shrunk from 20,000km<sup>2</sup> to less than 10,000km<sup>2</sup>. Where the communal land might have been expected to carry 500 elephants in 1995, the potential population is now less than 200.

The implications of this are two-fold. The fact that the elephants may have exceeded carrying capacity in the communal lands will result in some dispersing into the commercial farming areas but it will also result in ‘overstocking’ of elephants in the communal lands themselves. Elephants will not necessarily emigrate from the communal lands on the day carrying capacity is exceeded – more likely is a build-up of numbers and damage to the resource base.

All parts of the communal land will not reach ‘carrying capacity’ for humans simultaneously. Some conservancies will continue to provide space for elephants more than 10 years from now. Others had exceeded their carrying capacity in 1995. The expected year when each conservancy will reach carrying capacity for humans and, hence, be unable to support elephants is shown in Table 3 on the next page.

Only five conservancies are expected to still have land available for elephants after the year 2020 – Puros, Orupembe, Marienfluss, Kunene River and Sanitatas. Four of these are in full desert areas where the annual rainfall is about 100mm. Because of this, their carrying capacity for elephants is very low and amongst all four of them the potential elephant population in 2020 is less than 50 animals. Kunene River is the interesting exception: although it has roughly the same amount of land available in 2020 as the other four conservancies, because of its relatively high rainfall (over 300mm), it should be able to support about 130 elephants in the year 2020.<sup>17</sup>

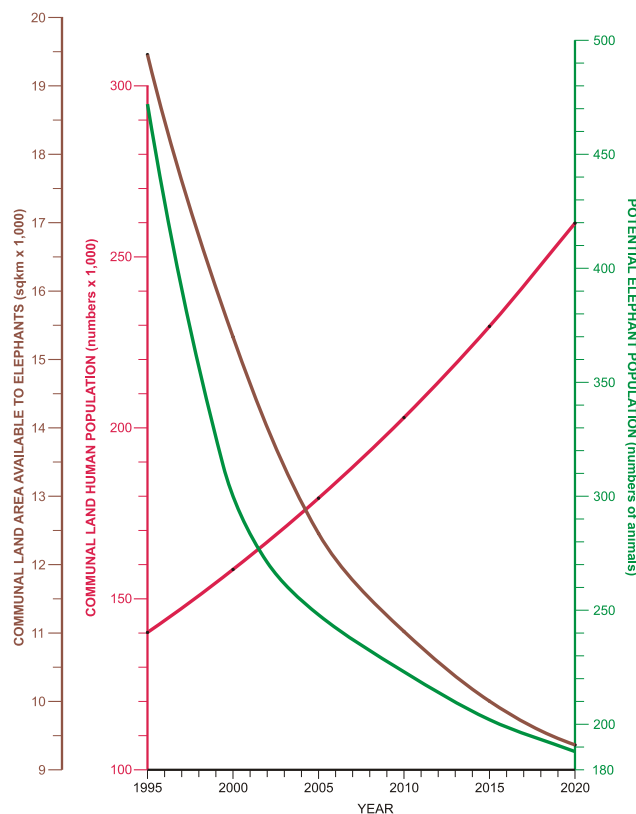

**Figure 7: Communal land population increase, shrinking range for elephants and expected decline in the elephant population**

17. Interestingly, Chris Eyre, working for IRDNC in the extreme north-west of Kunene Region, is attempting to manipulate the elephant movements away from the more densely populated parts of the communal land so that they move into Kunene River Conservancy.

**Table 3: Estimated areas available for elephants in individual conservancies 1995-2020**

Conservancies	Area km <sup>2</sup>	Rain mm	AREA REMAINING FOR ELEPHANTS										
			1995	1996	1997	2001	2003	2005	2009	2012	2013	2016	2020
Puros	3,568	90	3,037	3,024	3,010	2,953	2,921	2,889	2,818	2,761	2,740	2,677	2,584
Orupembe	3,565	100	2,811	2,792	2,773	2,691	2,646	2,600	2,500	2,418	2,389	2,299	2,167
Marienfluss	3,034	120	2,555	2,543	2,531	2,478	2,450	2,421	2,357	2,305	2,287	2,229	2,146
Kunene River	2,764	310	2,259	2,246	2,233	2,178	2,149	2,118	2,050	1,996	1,976	1,916	1,828
Sanitatas	1,446	110	1,012	1,001	990	942	917	890	832	785	769	717	641
Ehrovipuka	1,975	250	804	775	745	617	549	477	321	194	149	9	0
Torra	3,522	100	1,260	1,204	1,146	899	766	627	326	80	0	0	0
Sorri Sorris	2,290	150	693	653	612	438	344	246	34	0	0	0	0
Doro !Nawas	4,073	80	766	683	599	238	44	0	0	0	0	0	0
Sheya Uushona	5,066	380	792	685	575	109	0	0	0	0	0	0	0
Okangundumba	1,131	260	73	47	20	0	0	0	0	0	0	0	0
#Khoadi-//Hoas	3,366	170	94	12	0	0	0	0	0	0	0	0	0
Ruacana	2,993	360	0	0	0	0	0	0	0	0	0	0	0
Uukwaluudhi	1,437	400	0	0	0	0	0	0	0	0	0	0	0
Sesfontein	2,591	110	0	0	0	0	0	0	0	0	0	0	0
Ozondundu	745	230	0	0	0	0	0	0	0	0	0	0	0
Anabeb	1,570	180	0	0	0	0	0	0	0	0	0	0	0
Omatendeka	1,619	200	0	0	0	0	0	0	0	0	0	0	0
//Huab	1,817	200	0	0	0	0	0	0	0	0	0	0	0
Uibasen	286	130	0	0	0	0	0	0	0	0	0	0	0
//Audi	335	270	0	0	0	0	0	0	0	0	0	0	0
<b>Communal Land</b>	<b>Area</b>	<b>Rain</b>	<b>AREA REMAINING FOR ELEPHANTS</b>										
<b>Rainfall</b>	<b>km<sup>2</sup></b>	<b>mm</b>	<b>1995</b>	<b>1996</b>	<b>1997</b>	<b>2001</b>	<b>2003</b>	<b>2005</b>	<b>2009</b>	<b>2012</b>	<b>2013</b>	<b>2016</b>	<b>2020</b>
<100mm	393	50	145	139	133	106	91	76	43	16	6	0	0
100-200mm	9,812	150	2,236	2,047	1,853	1,026	581	114	0	0	0	0	0
200-300mm	12,970	250	620	311	0	0	0	0	0	0	0	0	0
300-400mm	6,909	350	300	135	0	0	0	0	0	0	0	0	0

The category 'Communal Land' in the table above is that part of the communal land in Kunene Region where there were no registered conservancies in 2008. It does not have much potential for elephants because of the relatively high human densities in the higher rainfall areas.

#### 4. A Simulation Model

The model (**Fig.8**) attempts to simulate year by year all of the various processes which affect the growth of elephant populations and their dispersal in Kunene Region. The model is described in **Appendix 2** (page 46). The assumptions underpinning the model are listed below.

##### a. Etosha National Park

Etosha could be seen as the ‘engine’ driving the system. Its carrying capacity is assumed to be constant (1,918 elephants) and the population is assumed to increase at a rate of 3.3% per year. The model starts in 1995 when it is assumed that the population was 2,000 animals. A proportion of the surplus animals above carrying capacity are assumed to emigrate from the park every year.

Emigration takes place to the north-west and west of the park and not directly into the commercial farming area south of Etosha.<sup>18</sup>

##### b. Skeleton Coast and Concessions

The carrying capacity for these areas remains constant but it is low (133 elephants).

##### c. Conservancies and other communal land

The model deals individually with 22 conservancies and 4 parcels of ‘other’ communal land,<sup>19</sup> each with its own human population which increases as each year of the model advances. The carrying capacity for elephants in these areas is recalculated every year as the available range for elephants decreases.

##### d. Private Land

Although there is a small resident elephant population within the commercial farm land of Kunene Region, it is disregarded in this analysis which focuses on the number of elephants likely to emigrate from the rest of the north-west into private land farms as elephant populations outside Etosha increase and the available range shrinks. The options for these elephants are explored in the section on Management (pages 19, 29). For now, the commercial farms can be regarded as a ‘sink’ area where all elephants are destroyed on arrival.

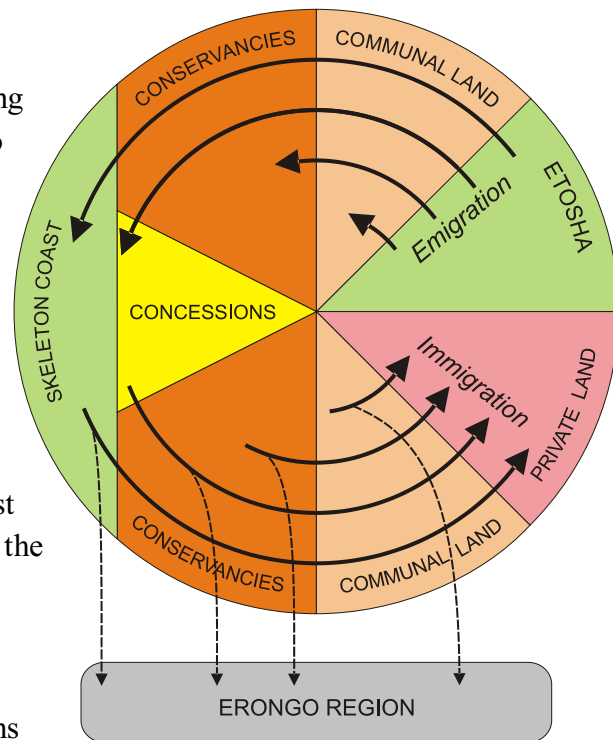
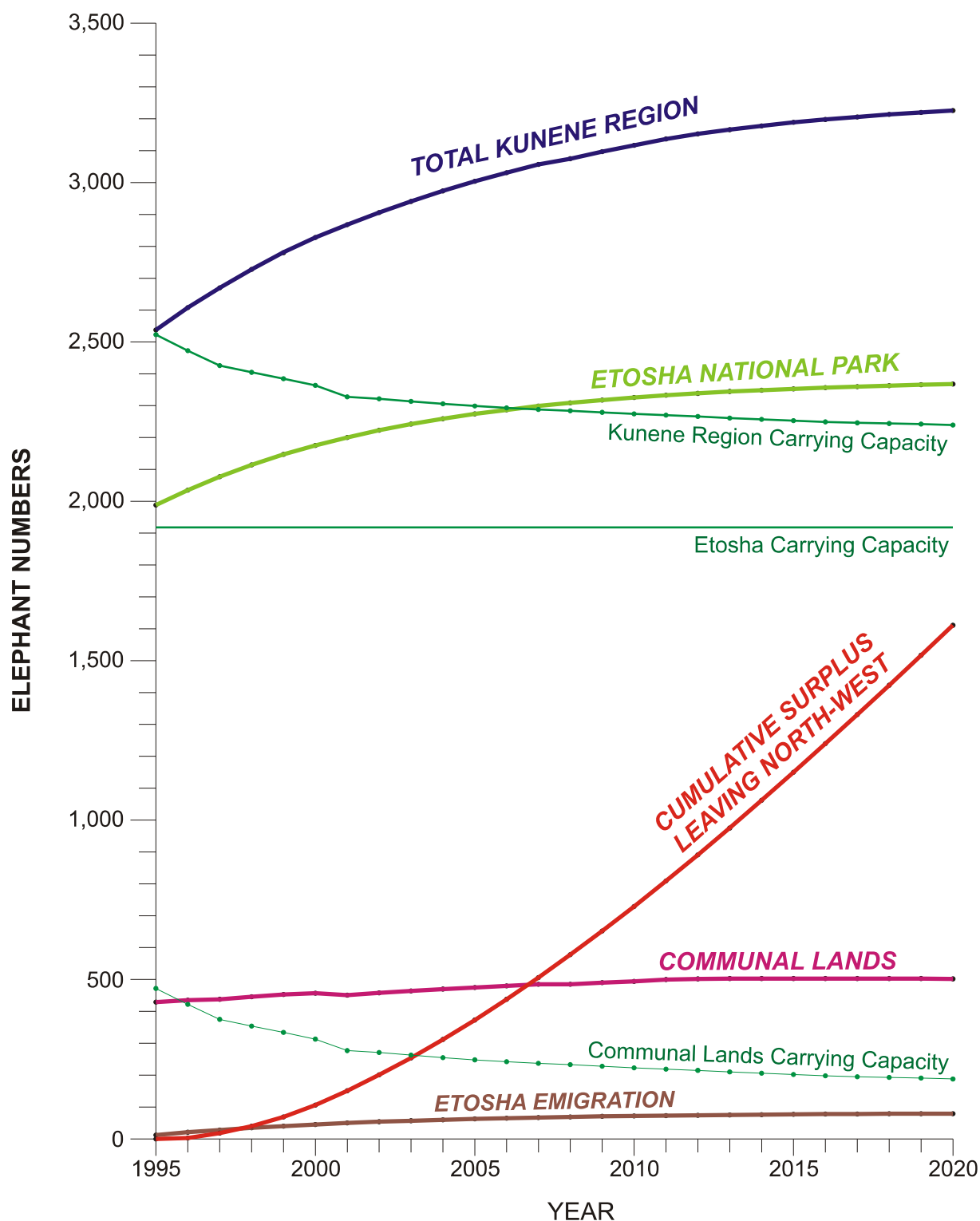

**Figure 8: Kunene Region simulation model**

18. The number of ‘break-outs’ through the southern boundary fence of the park are very few (less than five per year). In contrast, I counted 14 places on the western boundary in November 2008 where the fence had been damaged and, presumably, some elephants had crossed the boundary.

19. The ‘other’ communal land is that land on which there were no registered conservancies in 2007. It has been divided into 4 areas lying between the annual rainfall isohyets spaced at 100mm.

The expected changes which have taken place in the Kunene Region elephant population since 1995 and which will take place from now up until the year 2020 in the absence of any management of the population are shown in **Fig. 9** below. The results are from the simulation model described in **Appendix 2**. The scenario does not include any trophy hunting of elephant.



**Figure 9: Dynamics of the Kunene Region elephant population under no management**

The components of the Kunene Region elephant population, as shown in **Fig.9** on the previous page, are described below.

### **Etosha National Park**

The population increases from 2,000 elephants in 1995 to reach about 2,400 animals in 2020. It is just above carrying capacity at the start in 1995 and, with the emigration of 15% of the surplus above carrying capacity, its growth rate declines and the population becomes constant around 2030. At this stage it is some 400 animals above carrying capacity and, one assumes, it is 'mining the capital' out of the park and competing with other species for food.

The annual emigration from Etosha is shown at the bottom of Fig.9. The numbers are relatively low starting with 12 animals in 1995 and rising to 79 animals in 2020. This emigration is sufficient to stabilise the population by the year 2030, being exactly equal to the annual breeding increment.

### **Skeleton Coast National Park and the communal land concessions<sup>20</sup>**

The carrying capacity for these areas is low (in total about 133 animals) and, assuming that there is no settlement in them, it remains constant. The population builds up from 121 animals in 1995, exceeds carrying capacity in 1996 and ends up being nearly three times greater than carrying capacity in 2020 (360 animals).<sup>21</sup>

### **The communal lands**

The communal lands carrying capacity declines from some 500 animals in 1995, when the elephant population is just below carrying capacity, to under 200 animals in the year 2020. The elephant population starts at a level of slightly over 400 animals and increases to just over 500 animals by the year 2020 (300 elephants more than the assumed carrying capacity). At this stage, despite the immigration from Etosha, the population is more or less constant as animals emigrate from the communal lands into Erongo Region and the commercial farming areas in Kunene Region. As with Etosha, the elephant population is capable of living with this situation but the long term implications are not desirable.

By the year 2020 the entire area outside Etosha is acting simply as a 'throughput' system. The animals immigrating from Etosha together with the annual population increment resulting from breeding in the north-west is being 'exported' in the same year.

---

20. These concessions (Palmwag and Etendeka) are currently being incorporated into a contractual park with the agreement of the neighbouring conservancies.

21. This is because of the model process by which the elephant population in any given year is allocated to the available areas. No animals are allocated to communal land areas which have exceeded their carrying capacity for human beings. Thus Skeleton Coast and the concessions become a larger and larger proportion of the available elephant area as the communal land carrying capacity shrinks.

**Emigration from the north-west**

The cumulative numbers invading the commercial farming areas within Kunene Region and emigrating across the Ugab into Erongo Region are shown in **Fig.9**. From 1995 to 2020 a total of over 1,600 elephants have been ‘exported’! Assuming about 100 of these have managed to remain on the private land in Kunene Region and another 200 have found homes in Erongo Region, this still leaves some 1,300 elephants unaccounted for. If the model is any way close to a simulation of the real process, it must be assumed that the commercial farming areas are indeed acting as a ‘sink’ for elephant.

It is stressed that the results presented are one possible outcome of a modelling process based on scanty data and one under which a number of variations are possible. Nevertheless, even if this model is less than perfect, the true process governing the relationships between elephants and people in Kunene Region is unlikely to be dissimilar.

This leads logically to an examination of management options for the north-west elephants.

---

## MANAGEMENT OPTIONS

In this section, several management options for the north-west elephants are explored.

- Scenario 0. This is the ‘no management’ scenario described in the previous section. The only income is from ‘found’ ivory arising from natural mortality.
- Scenario 1. No Management except for elephant trophy hunting in the north-west.
- Scenario 2. Cull elephants in Etosha National Park to keep the park population below carrying capacity.<sup>22</sup> Trophy hunting continues outside the park.
- Scenario 3. Cull elephants outside Etosha National Park to keep the north-west elephant population below carrying capacity. Trophy hunting continues outside the park.
- Scenario 4. Cull elephants both in Etosha National Park and in the remainder of the Kunene Region to keep both subpopulations below carrying capacity. Trophy hunting continues outside the park.

The potential scenarios on private land are –

- a. All elephants are destroyed when they enter the commercial farming area. The value of the products is calculated.
- b. The sustainable quota of trophy bulls is sold on elephant hunts and the remainder are destroyed.
- c. All elephants survive and are used sustainably to maximum advantage.

The Kunene Region model used in previous section and described in **Appendix 2** (page 46) is not suitable for testing management scenarios such as numbers which have to be culled and sustainable hunting quotas. To be able to do this, I have used a full elephant population simulation model (**Appendix 3**, page 52) and adapted it to cope with emigration and immigration. I have also examined a longer time frame (1995-2075) because the average outcomes of the processes taking place can only be found from a longer period.

For comparative purposes, the results are presented for the key variables from all four scenarios rather than examining all the key variables for one scenario at a time.

### 1. North-West elephant population numbers

In the first scenario shown in **Fig.10** on the next page, the elephant population outside Etosha National Park behaves much as shown in **Fig.9** (page 16). The small number of male elephants taken as trophies do not prevent the population from increasing to just under 1,000 animals – about 600 more elephants than the long-term carrying capacity of about 333 elephants. After 80 years, the only areas in the communal land which have not yet reached carrying capacity for people are three conservancies in the very arid zone. Skeleton Coast National Park and the communal land concessions host a substantial part of the of the elephant population.

---

22. The practice of culling is endorsed in the new HWC Policy (MET 2009, page 18).



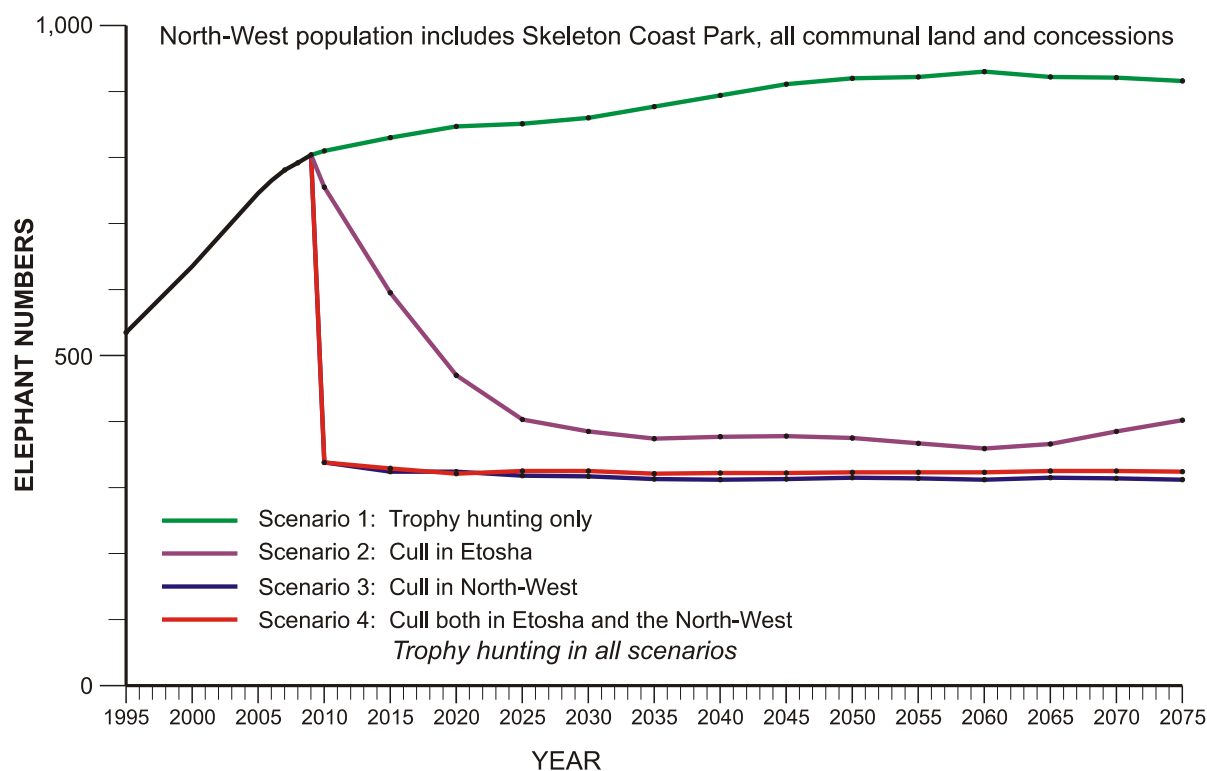
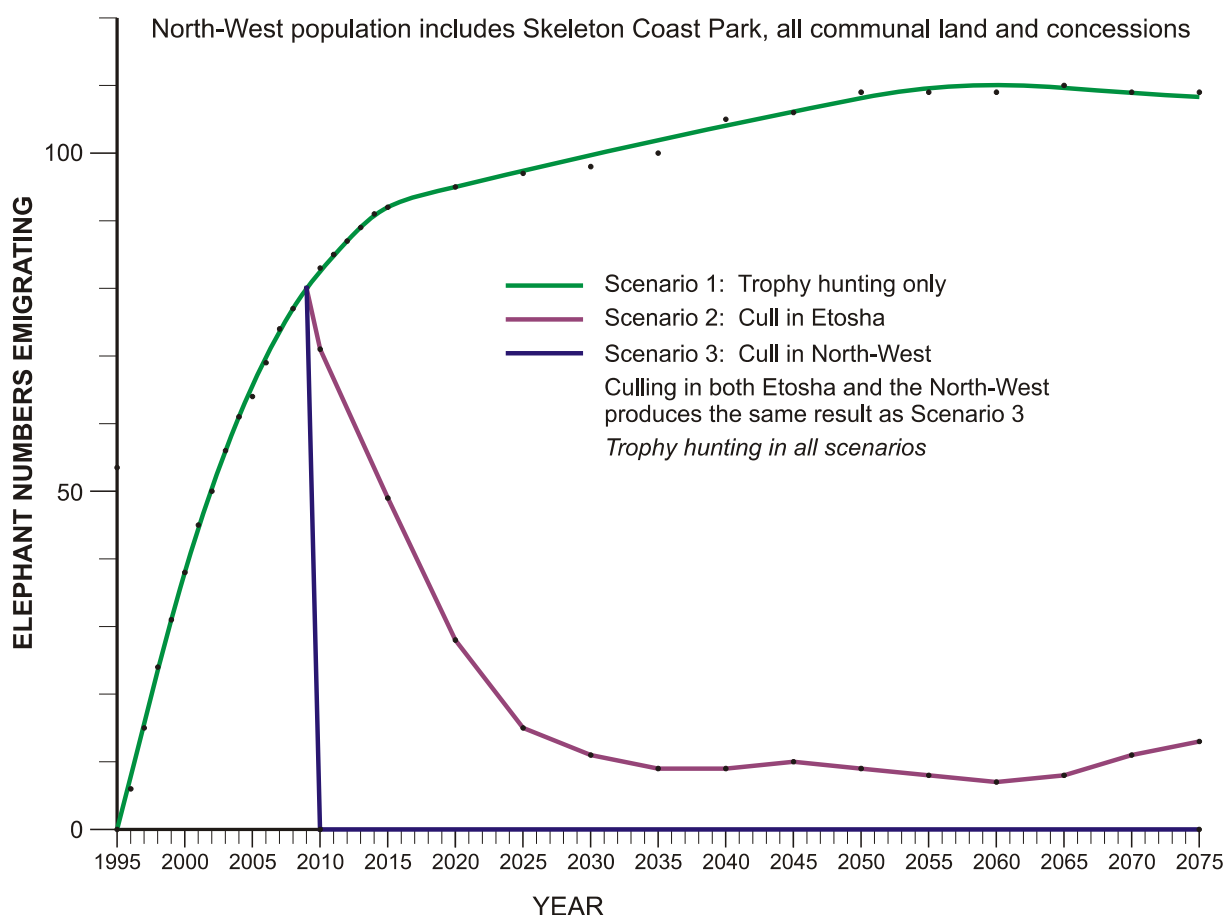

**Figure 10: The north-west elephant population under various management treatments**

In **Scenario 2** where, starting in the year 2010, elephants are culled annually in Etosha to keep the population at an estimated carrying capacity of 1,900 animals, there is no emigration of animals into the north-west. After an initial build-up of the north-west population to about 800 animals in the year immediately before culling starts in Etosha, the population starts decreasing as its numbers are not being augmented from Etosha and it is able to ‘export’ a part of its surplus to the commercial farming area and Erongo Region. The population stabilises at about 380 animals and the annual surplus migrating out of the north-west is an average of about 10 elephants.

In **Scenario 3** where culling takes place outside Etosha National Park to maintain the elephant population at the carrying capacity for the north-west, the population is reduced very sharply in the year 2010 to 340 animals – which is what the carrying capacity has been reduced to as a result of human population growth and a concomitant increase in livestock numbers. Thereafter, the population declines very slowly as the carrying capacity continues to decrease. An undesirable situation arises which is not reflected in **Fig.10** above. Because the assumed method of culling is the removal of complete cow herds, over a long period the sex ratio of the population shifts to almost 2 males to one female. The method of setting hunting quotas ensures the offtake of the maximum sustainable yield of high quality hunting trophies – however the hunting offtake is not enough to balance the sex ratio in the population given the numbers emigrating from Etosha National Park. The result is that more and more females are culled in an attempt to bring population down to the specified carrying capacity – where the problem lies in a superabundance of males.

This situation does not arise in **Scenario 4** where there is no immigration from Etosha. The male part of the population is not excessively swelled and the conventional culling of cow herds combined with trophy hunting maintains a sex ratio slightly in favour of females.



**Figure 11: Emigration from the north-west under various management scenarios**

## 2. Emigration from the North-West

The total emigration referred to includes elephants entering the commercial farming districts within Kunene Region and animals entering Erongo Region to the south (page 17). In the Kunene Region simulation model (**Appendix 2**, page 46), it is assumed that half of these surplus elephants find their way into Kamanjab farming area (and beyond). Under **Scenario 1** in **Fig.11** above, the level of emigration rise to an asymptote of about 110 animals leaving the north-west annually. By the year 2050 the numbers leaving more or less balance the emigration into the north-west from Etosha and the annual breeding increment in the north-west population.

When culling takes place in Etosha and all emigration from Etosha into the north-west ceases (**Scenario 2**), the number of animals leaving the north-west falls sharply and bottoms out at an average of about 10 elephants per year (about 15% of the annual north-west population increase).

When culling takes place in the north-west (**Scenarios 3 & 4**) and the population is reduced to the carrying capacity for the north-west, no emigration (by definition) takes place.

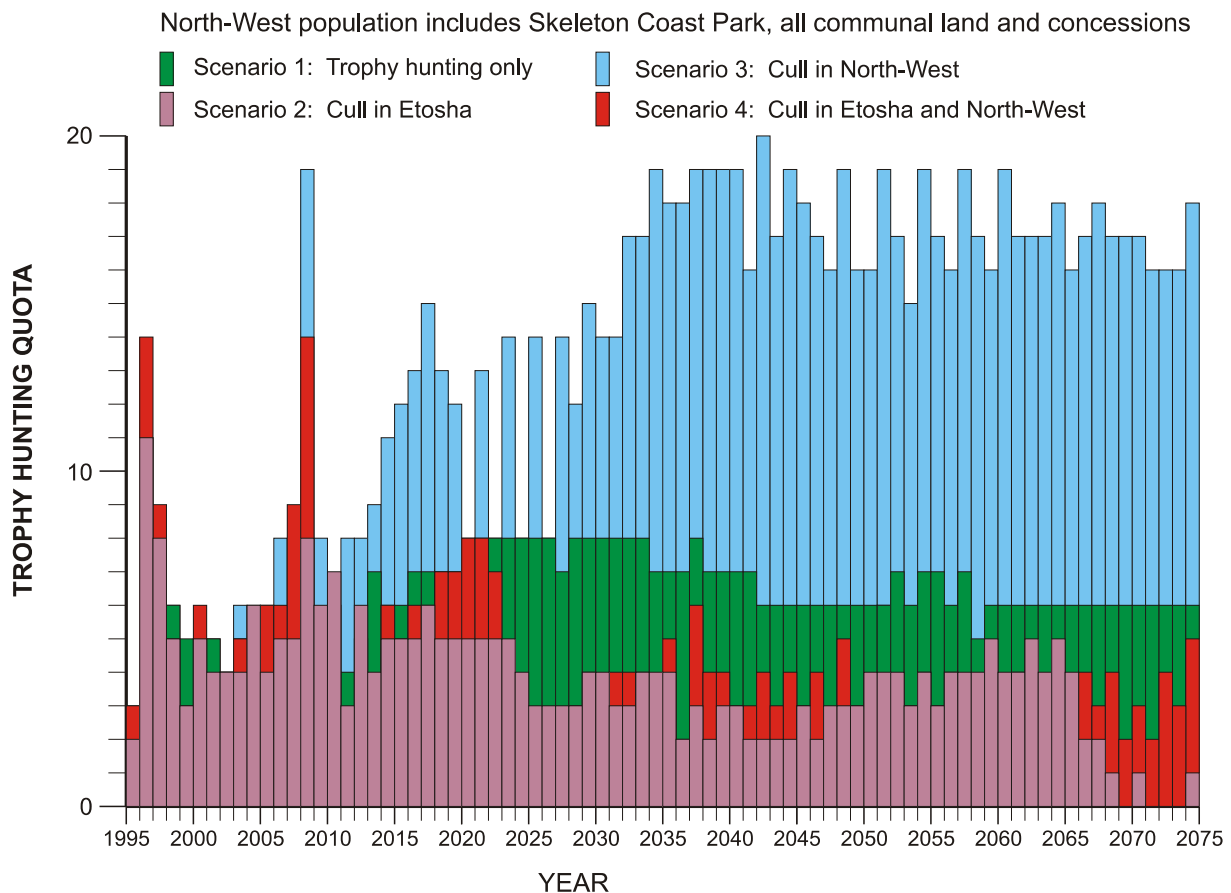

**Figure 12: Sustainable trophy hunting quotas in the north-west**

### 3. Trophy hunting in the North-West

The method of setting hunting quotas is described in **Appendix 4** (page 57). The quotas are set automatically year by year in the population simulation model based on the record of average trophy tusk weights. In all the scenarios in **Fig.12** above, it is assumed that the area of the north-west available for trophy hunting includes all communal land, all communal land concessions and Skeleton Coast Park. In practice, hunting would probably not take place within the park but its proportion of the annual hunting quota is so low that it can be ignored.

The highest quotas arise under **Scenario 3** where there is no culling taking place in Etosha (and emigration from the park is in full swing) and where there is culling in the north-west.<sup>23</sup> About twenty years after the inception of culling, the combination of the skewed age structure and the ongoing immigration from Etosha allows quotas of over 5% of the total north-west population (i.e. an average of 17 bulls per year). The very odd age and sex structure of the population which results from this combination of immigration and culling was remarked upon on page 20.

23. Hunting quotas can be almost doubled when an elephant population is under a culling regime involving the removal of cow herds (Martin 2004a). The long-term effect of culling is to skew the population age structure in favour of adult males.

Under **Scenario 1** (no culling anywhere in Kunene Region), the long term sustainable quota is about 0.6% of the population (6 trophy bulls per year). Under **Scenario 2** where there is culling in Etosha and no emigration into the north-west, the north-west population is much smaller and can sustain an average of only about 3 bulls per year in the long term. When there is culling in both Etosha and the north-west (**Scenario 4**), the trophy percentage offtake from the population rises to almost 1% – however, because of low population numbers in the north-west, this still only amounts to about 3 bulls per year.

#### 4. Culling Offtakes

One of the main reasons for using a population simulation model to examine the various management scenarios was to be able to determine the required numbers which would have to be culled in order to limit the elephant population to its estimated carrying capacity. When the method of culling is to remove entire breeding herds – which is a generally preferred option – the numbers which have to be removed are lower than would be expected from a simple subtraction of the actual population number from the desired population. This is because the culling is targeting the breeding females preferentially.

In **Fig.13** on the next page, the numbers required to be culled under **Scenarios 2, 3 & 4** are estimated. Each culling operation is shown as starting with a very large offtake in the year 2010 in order to bring the population immediately to carrying capacity. In practice, these large culls could be spread over two or three years in order to make less demand on resources and to avoid a glut of elephant products in a single year.

The highest required offtakes are in the north-west under **Scenario 3**, where the culling is dealing not only with the resident north-west population but also the assumed annual emigration from Etosha. It requires an initial offtake of some 560 animals followed by an average of about 70 animals per year to keep the population from exceeding its carrying capacity.

To keep the Etosha elephant population at its nominal carrying capacity of 1,900 animals requires an offtake of 480 animals in the year 2010 followed by a series of decreasing culls (from 58 animals in 2011 to 41 animals in 2028) until the population achieves its new stable age structure when an annual offtake of 40 elephants will maintain the *status quo*. This amounts to 2% of the total population.<sup>24</sup>

If there is culling in Etosha, the numbers needed to be culled in the north-west are much smaller. In **Scenario 4** it requires an initial offtake of 496 animals in 2010 (to deal with the excess of elephants already present) followed by an annual average cull of less than 10 animals. This is because of the very low growth rates for elephants living in desert and semi-desert situations.

---

24. It is of interest to note that a selective offtake of 2% will prevent population increase in an elephant population with an intrinsic growth rate of 3.5%.

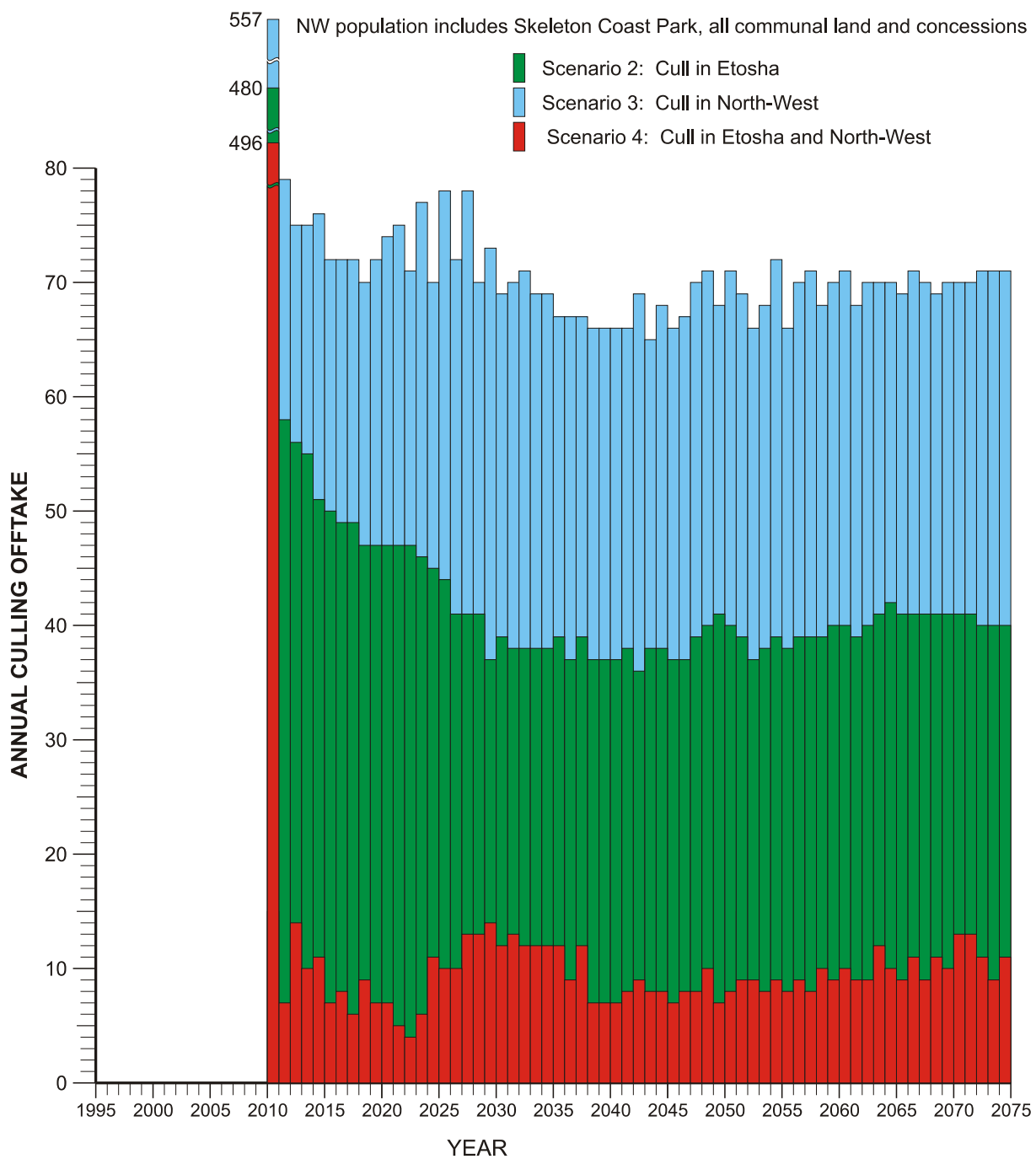

Figure 13: Required culling offtakes under the management scenarios

## 5. Financial Implications

The simulation model used for examining the various management scenarios (**Appendix 3**, page 52) also costs all simulation runs and had been used here to evaluate the 5 scenarios presented in this section. The prices and methods used in the calculations are as follows –

### **Culling**

Ivory: Individual tusk weights are calculated for all animals killed and priced according the schedule of prices for different tusk weights which obtained before the elephant was listed on **Appendix 1** of CITES in 1989.

Skin: The amount of skin produced by each animal culled is estimated from an allometric relationship and priced at US\$5/kg which is the current rate for dry salted crust elephant skin in legal South African and Botswana markets.

Meat: The body weights of all animals culled are estimated from an allometric formula and a dressing out percentage of 33% is used to calculate the total quantity of wet meat produced. Wet meat is priced at US\$1/kg.

Sale of live calves: Apart from the sale of live calves to zoos which has been taking place for a very long time, a new market has sprung up in the southern Africa tourism industry seeking elephant calves between the ages of 3-10 years for domestication. The price of these animals (US\$2,500 each) now provides a significant component of the income from any culling operation. The only constraint is that an overproduction of such calves is likely to see a decrease in the selling price. In the model, the number of calves between the ages of 3-10 years old likely to be killed in any particular culling operation is calculated and 75% of these are assumed to be captured for the live sales market.

Costs: Based on the experience of Zimbabwe culling contractors, the cost of culling has been set at US\$300 per animal.<sup>25</sup> This same cost has been applied to all calves captured alive.

### **Elephant Trophy Hunting**

Trophy bull elephants are assumed to be sold on a minimum of 20 day hunts. Although there is a significant market for trophy hunting of cows, Martin (2004a, 2005) gives strong arguments against this being allowed to take place.

Trophy fees: The trophy fee charged to the hunting client is assumed to be US\$10,000.

Daily rate: The daily rate for a single hunting client is assumed to be US\$1,000 per day.<sup>26</sup>

Elephant products: All skin and meat from trophy elephants has been included in the financial value of an elephant hunt at the same prices used to evaluate culling operations.

### **Found ivory**

The expected deaths from natural mortality in all scenarios have been tabulated annually and, assuming that 75% of all tusks from natural mortality are found, the total production of ivory for the relevant age classes has been used to calculate the expected income from this source.

25. Scholes & Mennell (2008, p382) estimate the average cost of culling in Kruger at US\$600/animal.

26. These two figures put the gross value of an elephant hunt at US\$30,000. On a recent analysis of the Botswana hunting industry it was found that the average price of an elephant hunt was US\$53,000 (Martin 2008b).

In **Table 4** below, the value of the three large culls which would take place in 2010 under **Scenarios 2,3 & 4** are presented. These are 'one-off' items and should be seen more as a conversion of capital than as a form of income.

**Table 4: Net income from major culls in 2010 (US\$)**

Scenario	Calves	Meat	Skin	Ivory	Gross income	Costs	Net income
2 Cull in Etosha	345,000	228,000	98,000	718,000	1,390,000	144,000	1,246,000
3 Cull in NW	328,000	326,000	136,000	1,355,000	2,145,000	169,000	1,976,000
4 Cull in both	643,000	512,000	217,000	1,868,000	3,240,000	293,000	2,947,000

The average annual income for each scenario has been obtained from the mean values of the simulation runs over the years 2045-2144 when conditions are stable. These are presented in **Table 5** on the next page and some interesting observations can be made on the figures.

In the first scenario where there is no management and no trophy hunting, the only income is from found ivory resulting from natural mortality. With a 75% finding factor, the value of this ivory in the north-west is some US\$171,000. In the next scenario (**Scenario 1**) where trophy hunting is taking place, the total financial returns from the system hardly change. Why, when the hunting is generating US\$137,000? The answer lies in the amount of found ivory – the tusks from the large males which were providing the major part of the income from found ivory in **Scenario 0** are now being taken by safari hunters and the value of found ivory has dropped from US\$171,000 to US\$47,000.

Elephants are one species where the commodity value of their products actually exceeds the value that can be realised from trophy hunting. Martin (2007) showed that unless hunting clients are charged in full for the ivory value of their trophies, it is financially better to kill the animals and sell the ivory on the commercial market.<sup>27</sup> There is an additional more subtle effect happening. Were a particular potential trophy elephant to die of natural causes, the local community would get the benefit of the ivory value: where they allow the animal to be killed by a hunting client, they lose heavily.

In **Scenario 2**, which entails culling elephants in Etosha National Park, several unexpected results arise. The culling produces an annual income of about US\$71,000 and, of this, ivory contributes less than US\$30,000 – because most of the tusks are small when cow herds are culled. This gives the lie to those critics who believe culling is done to make money from ivory. What is extremely interesting is that the average income from found ivory rises to over US\$500,000 per year. This is because, as a result of culling cowherds, the population age structure alters to favour males. Being in a national park, these males are not subject to trophy hunting and end up dying naturally – hence the huge income from found ivory.

In the same scenario, the value of trophy hunting outside Etosha drops markedly because there is no emigration from the park (from US\$137,000 per year in **Scenario 1** to US\$55,000 in **Scenario 2**). The value of found ivory decreases by a similar proportion. Most of the money from **Scenario 2** accrues to the State.

27. It might be argued that the listing of elephants on Appendix I of CITES has made the sale of ivory problematic. The illegal market is alive and well and is paying the correct prices.

**Table 5: Average total income from elephant management***All figures in United States dollars (US\$1 = N\$7.84 on 25 August 2009)*

Scenario	CULLING							TROPHY HUNTING						Found Ivory	TOTAL NET INCOME	
	Calves	Meat	Skin	Ivory	Gross income	Costs	Net income	Hunts	Meat	Skin	Gross income	Costs	Net income			
0 No management	ENP														367,000	
	NW														171,000	538,000
1 NW trophy hunting	ENP														367,000	
	NW							186,000	10,000	3,000	199,000	62,000	137,000	47,000	551,000	
2 Cull in Etosha	ENP	30,000	16,000	7,000	30,000	83,000	12,000	71,000							539,000	
	NW								75,000	4,000	1,000	80,000	25,000	55,000	22,000	687,000
3 Cull in NW	ENP														367,000	
	NW	56,000	31,000	13,000	88,000	188,000	21,000	167,000	506,000	28,000	7,000	541,000	169,000	372,000	11,000	917,000
4 Cull in both	ENP	30,000	16,000	7,000	30,000	83,000	12,000	71,000							539,000	
	NW	10,000	600	400	500	11,500	3,000	8,500	98,000	5,000	1,000	104,000	33,000	71,000	20,000	709,500



The highest average annual income is produced under **Scenario 3** where both culling and hunting take place in the north-west outside Etosha (US\$917,000 of which US\$550,000 would go to local communities). Effectively, the communal land takes the income away from the State by doing their 'dirty work'! However, it has been pointed earlier (page 20) that the long term result of this regime is not healthy – the augmentation of the number of males in the north-west from the ongoing emigration from Etosha produces a highly skewed population age structure which cannot be rectified by trophy hunting. It could be rectified by culling a number of males outside cow herds but this would require careful monitoring to ensure that it does not ultimately damage the trophy hunting industry.<sup>28</sup>

The income from **Scenario 4** is high (US\$710,000 per year = N\$5,600,000) and it does not carry with it the age structure problem mentioned above. Moreover, it would probably be beneficial for the park because no amount of culling outside Etosha will address the problem of overpopulation and vegetation damage inside the park. Of the total income generated from **Scenario 4**, US\$610,000 would accrue to the State and US\$100,000 would belong to the people of the north-west.

Disregarding for the moment the question of who gets the income from the management, the land use value of the elephant management in the north-west under **Scenario 3** (US\$550,000) amounts to a net return of about US\$8/km<sup>2</sup> when the total area of the Region outside Etosha (and excluding the private land) is considered. The return is significant, given the arid terrain from which it is derived.

It becomes much more significant if it is applied to the individual conservancies who should receive this return. By the year 2020, the only conservancies which will be able support elephants (according to the model) are Marienfluss (3,034km<sup>2</sup>), Kunene River (2,764km<sup>2</sup>), Orupembe (3,565km<sup>2</sup>), Sanitatas (1,446km<sup>2</sup>) and Puros (3,568km<sup>2</sup>), i.e. a total of 14,377km<sup>2</sup>. The return rises to US\$38/ km<sup>2</sup> if it is assumed (reasonably) that they should receive the entire income. The number of people in these conservancies in 2020 will be about 4,000 so that the income would represent a dividend of US\$134 (N\$1,050) per person per year.

---

28. The adoption of a system of sink areas in the communal lands would obviate this problem – the selectivity for males arising from culling complete cow herds should not arise.

## 6. Elephants in the Commercial Farming Area

The potential scenarios on private land were listed on page 19 and are examined below.

### a. All elephants are destroyed when they enter the commercial farming area

Assuming that the only management taking place in the Region is trophy hunting in the communal land, then the conditions of **Scenario 1** (page 19) apply. Under this scenario, the number of elephants entering the commercial farming area within Kunene Region (Kamanjab, Otjikondo, Outjo) is estimated at 40 in 2009, rising to 55 in 2050 when it remains more or less constant. Assuming that the invading elephants have a population age and sex structure typical of the larger population which they have left, then the annual long term income which could be derived from killing them all when they enter the farming area is –

**Table 6: Net income possible from destroying all elephants entering private land**

Meat US\$	Skin US\$	Ivory US\$	Gross income US\$	Costs US\$	Net income US\$    N\$	
40,819	17,231	293,405	351,455	16,500	334,955	2,626,047

The ivory value is particularly high because this differs from a normal culling operation which involves only cow herds. The adult males contribute the bulk of the ivory value. Of course, this assumes that the farmers could realise the full value of the ivory – which, under present CITES constraints, may not be possible.

### b. Trophy elephants are sold on hunts and the remainder are destroyed

The number of elephants entering the commercial farming area in future years is likely to be about 55 annually according to the model. This is not enough to provide one trophy bull per annum under conventional methods of quota setting (maximum of 0.6% of the total population in an unmanaged situation). At best it, would allow one ‘warrantable’ trophy every three years. It is at this stage that conventional analytic recipes for quota setting break down. Left to their own devices, it is quite likely that the farmers in the Kamanjab area would be able to locate one or more trophy bulls each year and sell these to best advantage. But to achieve this requires almost total deregulation from government. The only valid rôle of government in this situation would be to prohibit the hunting of cow elephant because, ultimately, this will bring the entire Namibian safari hunting industry into disrepute.

Therefore it is not possible to make an estimate of the potential income which might be earned from hunting a few bulls in the commercial farming area on an *ad hoc* basis. Such hunting is unlikely to produce a greater income than that which can be derived from the commodity value of destroying all elephants when they enter the farming area (see discussion on page 26) – except if Namibia is unable to escape the burden which the present CITES constraints place on the sale of ivory.

c. All elephants survive and are used sustainably to maximum advantage

If we ignore for the moment the reality that most of the commercial farmers on private land in Kunene Region are engaged in the business of cattle production and wildlife is no more than a secondary form of land use, it is possible to estimate what income could be derived from an elephant population close to carrying capacity in the commercial farming area.

The potential elephant population which could be carried sustainably in the 25,000km<sup>2</sup> of private land in Kunene Region, assuming there were no cattle, is estimated at about 2,500 animals (Table 3, page 11). Assuming a starting population of 80 animals in the Kamanjab farming area<sup>29</sup> and given the modelled number of invasions of elephant and a population growth rate of 3.5%, the elephant population would exceed 2,500 animals in 2033. If this population were managed through annual culling to remain at a level of 2,500 animals and to yield a sustainable offtake of trophy bulls,<sup>30</sup> the potential income from the population is shown in Table 7 below.

**Table 7: Net income possible from elephants on commercial farm land in Kunene Region**

The values in the table have been derived from simulating the long-term stable population resulting from the management regime above.

It requires an annual cull of 86 animals to maintain the population at 2,500 elephants. It has been assumed that of this number, 30 animals between the ages of 3-10 years old would be captured and sold alive, and 56 would be killed.

Because of the change in age and sex structure brought about by culling, the hunting quota can be raised to slightly over 1% of the total population giving 27 trophy bulls annually. This quota will maintain a mean trophy weight of 20kg and is sustainable. By charging the hunting clients the full market value of the ivory on top of all other charges (US\$559,600, the hunting becomes more profitable than simply killing the animals for their commodity value.

The value of found ivory is not high because the large tusks are taken as trophies.

Management	US\$	N\$
<b>CULLING</b>		
Calf sales	75,900	595,056
Meat	28,600	224,224
Skin	13,200	103,488
Ivory	68,400	536,256
Gross Income	186,100	1,459,024
Costs	25,900	203,056
Net Income	160,200	1,255,968
<b>HUNTING</b>		
Hunting	820,500	6,432,720
Meat	44,600	349,664
Skin	11,400	89,376
Ivory	559,600	4,387,264
Gross Income	1,436,100	11,259,024
Costs	273,500	2,144,240
Net Income	1,162,600	9,114,784
FOUND IVORY	63,800	500,192
<b>NET INCOME</b>	<b>1,386,600</b>	<b>10,870,944</b>
Land Use US\$/km <sup>2</sup>	55	435

29. Avis (2003a) refers to 80 elephants permanently present in Kamanjab farming area on farms Chairoros (27), Hirabis-sud (28), Ureis-Ekango (29), Cauas-Okawa (30), Klein Westfalen (245), Stienie (262), Picollo & Eensaamheid (259) and Huab (261) [Olifantsdood (260) should be added to this list].

30. It is assumed that hunting clients would be charged the full value of the ivory taken as trophies over and above the trophy fees and daily rates (see discussion on page 26).

Barnes (2009) estimates the typical net cash income from cattle farming in Namibian savanna areas such as the Outjo District at about N\$9.5/ha. The estimated potential income from elephants at carrying capacity in the same area is about N\$4.5/ha (**Table 7**, previous page). Martin (1999) estimated that wildlife multispecies systems managed for trophy hunting in the same environment should produce a minimum net income of US\$3/ha (N\$25/ha), of which elephants would contribute about one-third. More recently, Martin (2008b) found that the average net land use value generated by the top twenty safari hunting concessions in Botswana was US\$11.2/ha.

A list of the commercial farms affected by elephants in the Kamanjab-Outjo farming district is given in **Appendix 5** (page 58). A minimum of 72 farms is involved and it is likely that more farms could be added to this list which was compiled in December 2008. The reports from individual farmers of damage done by elephants vary from N\$40,000 to N\$100,000 per year. I suspect that the true figure is nearer the top end of the range because most farmers report on the direct expenditure they have incurred and do not include their own time, vehicle mileage and the opportunity costs of disrupted cattle management programmes.

The income which would be generated by treating the commercial farming area as a 'sink' area for elephant was given in **Table 6** (page 29) as about N\$2.6 million. Shared amongst (say) 80 farms which have suffered elephant damage, each farm could receive N\$32,500 as compensation for the damage inflicted by the elephants. This assumes proper marketing of the products from the elephants, including the ivory. For such a system to work it would be vital that the management is carried out by the farmers themselves within an institution which includes all affected farmers and **which they have developed themselves**. It will not work if funds are held in a remote account administered by an external agency outside the farming district. The farmers must decide amongst themselves how compensation would be administered.

---

## DISCUSSION

In this study, two population simulation models have been used in an attempt to understand the dynamics of the elephant situation in Kunene Region. The first model involves both people and elephants in a geographic situation. It assumes population growth rates and carrying capacities for both people and elephants. Based on the assumed land requirements for people (and their livestock), the amount of land available for elephants is calculated and this decides their movements within the Region.

The concept of carrying capacity for domestic livestock in variable environments has been criticised by Behnke (*et al* 1993) and Scoones (1994) and their criticisms would apply equally to a deterministic modelling system which relies on defined carrying capacities for humans and elephants for its predictions. In defence of the model, (a) I can think of no other way to simulate the dynamic interaction between humans and elephants in a large landscape; (b) both of these carrying capacities are geared to rainfall which is the key variable which the cited authors see as driving the system; and (c) the modelling results should be seen as no more than hypotheses to be tested by adaptive management – which at all times should take precedence over any rigid prescriptions.

The underlying hypothesis in the model is that elephants will only disperse (or move from a particular locality) when their numbers have exceeded ‘carrying capacity’. This seems reasonable. The model provides for long time lags in this process – elephants are capable of overshooting ‘carrying capacity’ by a large amount and may remain in the same place for a long time ‘mining’ the ecological capital out of the system with only a small proportion emigrating.

The rules of the model are applied in a way which bears scrutiny. Once the human population in a particular locality exceeds its own ‘carrying capacity’<sup>31</sup>, no further elephants are allocated to that land in the model. The situation is different in the case of an area where people have not yet reached their carrying capacity but where the number of elephants is above their carrying capacity. The model allows the elephant population to continue to build up on that land, with a proportion of the overabundant elephants emigrating each year. How realistic this is, is debatable. Any self-respecting elephant who has just emigrated from Etosha and arrives at such a place may well take one look at the overstocked elephant slum and keep moving.

Interestingly, such a system eventually results in the annual emigration balancing the breeding increment in the particular locality and the (overstocked) elephant population levels off at an asymptote. Eventually the whole of the north-west simply becomes a staging post for the animals emigrating from Etosha – they pass straight through the communal lands within twelve months and enter the private land where resources (in their eyes) are available.<sup>32</sup>

- 
31. Exceeding ‘carrying capacity’ for people may not simply mean they have run out of living space. It may mean that their livestock numbers have reached the point where there is no available forage for elephants and hence their land can no longer be regarded as part of the potential elephant range.
  32. Equally there might be some sort of ‘domino’ effect operating. As elephants enter the northern communal land, a ripple effect results in some elephants leaving the communal land in the south.

The second model is an elephant population simulation model which operates with all the age classes of the population in place and attempts to faithfully mimic the annual breeding and mortality in the population under the specified management regimes. It has been specially adapted to provide for immigration into the population (from Etosha) and emigration out of the population when it exceeds carrying capacity. It has been used to test out the effects of management – culling and trophy hunting.

The results emerging from this study can easily be challenged on scientific grounds. It has been readily acknowledged that the entire edifice is built on a flimsy structure of poor data. Nevertheless, if this is not a true representation of the situation on the ground, **there must be some similar process taking place**. The model does at least satisfy the demands placed on it by the few known facts – i.e. it matches the few reliable elephant population estimates from Etosha and the north-west, it produces the growth rates in 1995-96 in the north-west elephant population derived from survey data and it mimics faithfully the elephant invasions into the commercial farm land in Kunene Region beginning in 1997-98.

It is worth returning to the key point of Cumming (2007) made in the Introduction (page 3) and noted by Scholes & Mennell (2008). There is nothing ‘natural’ about an elephant population which has been expanding in the north-west and Etosha National Park since the 1980s with very low levels of illegal hunting and no management interventions. Elephant numbers for time immemorial have been regulated by humans and we are now dealing with an unnatural situation where elephants in Kunene Region have exceeded their carrying capacity. The term carrying capacity is fraught with different interpretations but, for the Kamanjab farmers, the definition of Graeme Caughley<sup>33</sup> is probably appropriate –

“One brown bear in Kent is an overpopulation of brown bears”

The elephants in Kunene Region are in a unique situation. There are no other comparable cases that I am aware of in Africa where elephants have unrestricted access to a range of 120,000km<sup>2</sup> (**Table 3**, page 11). The commercial farming land in the Region has been excluded. It requires the prospective elephant manager to think at the scale of a very large landscape.

As described in the **Problem Statement** (page 4), we are dealing with an elephant population *in extremis*. Outside Etosha National Park (which this study suggests is already overstocked with elephants) the range available to elephants is shrinking, they are competing with domestic livestock for food and water and they are being forced to seek these resources in the commercial farming area. There would seem to be little alternative to a substantial reduction in their numbers.<sup>34</sup> How this is done is the subject matter which follows.

---

33. I think that Caughley made this observation in the course of a conference on the ‘Overabundance of Large Mammals in State Protected Areas’ in the 1980s.

34. A similar situation occurred with the hippo population in Gonarezhou National Park in Zimbabwe in the 1980s. Despite the fact that the numbers of hippo in the South-East Lowveld were lower than desired and the population could have been described as ‘Threatened’, it became necessary to cull them in the national park because there was nowhere they could migrate to and water supplies in the park were limited because of a succession of below average rainfall years. Every pool in the Lundi and Savé Rivers was becoming a ‘hippo slum’.

## Population reduction

Notwithstanding the huge range available to the elephants, the fact that they are entering the hostile environment of the commercial farming area suggests that they cannot find their food and water requirements in the rest of this range, i.e. they have exceeded its carrying capacity. Metaphorically it may be convenient to think of the elephants living on a high plateau with sheer cliff edges – due to overcrowding, some of them are being pushed over the cliff.

The ‘cliff’ could be seen as the ‘sink’ in a ‘Source-Sink’ management<sup>35</sup> system (there is a danger here of using too many metaphors!). One totally valid management option would be to eliminate all elephants entering the commercial farming area and treat this as a ‘sink’ in the landscape.<sup>36</sup> Their presence in the commercial farming area is inimical to the present land use system and they are not wanted (Avis 2003b).

A strong recommendation of such a management system is that it does not depend on any accurate population estimates in order to calculate the annual offtake from the population. It is an elegant application of adaptive management which will answer the question of the required offtake retrospectively over a period of time.

Of course, the answer may be precluded if the north-west elephants learn very quickly that entering Kamanjab farming area is certain death. In this case, the problem will simply be transferred to Erongo Region or the build-up in the communal land will reach even higher levels.

Treating all or part of the Kamanjab farming area as a ‘sink’ for elephants would provide a safety-valve in the commercial farming area but, according to the simulation model, would leave the remaining elephants in the north-west and in Etosha well above desired stocking levels. Earlier I referred lightly to elephant ‘slums’. Perhaps this should be taken more seriously. Once elephants exceed carrying capacity, a number of undesirable consequences arise. They begin to modify ecosystems unacceptably with undesirable consequences for other wild species – with which they are competing directly. The level of human-elephant conflict in the communal lands will increase and the ‘Kamanjab’ problem will be transferred to the communal areas.<sup>37</sup>

A similar application of ‘sink’ areas could be deployed in the communal lands to handle the excess number of elephants in areas where they are not wanted. If the population simulation model used in this study is to be believed, the numbers which would have to be removed to bring elephants within the carrying capacity of the conservancies and other communal land is shockingly high. Under **Scenario 3** (page 23), where there is no culling in Etosha and all population reduction takes place in the north-west outside Etosha, the initial offtake required is 560 animals (from a population of just under 800 elephants) and a continuing offtake of 70 animals per year to maintain the *status quo* i.e. a carrying capacity of about 320 elephants. The culling is not simply dealing with the inherent population growth of the north-west elephants, it is also coping with the assumed immigration from Etosha.

- 
35. ‘Source-sink’ management is that management where elephant are removed from a defined area within their range when they happen to be present in that area.
  36. The new Human-Wildlife Conflict Policy (MET 2009, Section 2.4.1, page 4) provides for the declaration of HWC zones where there are chronic conflict problems.
  37. On the field work accompanying this consultancy, I visited a number of communal land farmers west of Kamanjab who all complained vociferously about the impact of elephants on their farming.

The numbers to be culled will decline in the long term as the available range for elephants in the communal shrinks (cold comfort). In the very long term the only elephants in the north-west will be a population of slightly over 100 animals in Skeleton Coast National Park and the communal land concessions (shortly to become contractual parks).

One advantage of using a ‘source-sink’ management system is that the age structure of the elephant population should remain unaltered as a result of culling. The assumption is that the offtake in the sink area has the same age structure as the overall population. When conventional culling of cowherds is practised, the age structure of the population shifts in favour of males over a number of years. This allows large hunting quotas but it may have other undesirable effects.

The numbers to be removed in the communal lands drops markedly if there is culling in Etosha to deal with the emigration into the north-west. Under **Scenario 2** an initial cull of 480 elephants is needed in Etosha followed by an annual maintenance cull of 40 animals. If this is done then the required offtake in the north-west (**Scenario 4**) is initially 500 animals (the population has been swelled to 800 animals by years of emigration from Etosha) but thereafter an annual cull of 10 animals will maintain the north-west population at carrying capacity.

What if the population model on which these findings are based is totally incorrect and the situation is nowhere near as grave as portrayed? There is a very simple way to find out. Instead of a massive initial offtake of elephants, population reduction could be carried out in a series of smaller tranches taken from sink areas, watching all the time the numbers of elephants entering Kamanjab farming area. When this number becomes zero, it can be assumed that elephants have been brought within the carrying capacity of the north-west.

I am not insensitive to the local, regional and international outcry which would confront such management. The ‘desert elephants’ occupy a special niche in the hearts and minds of thousands of people and the mere thought of killing large numbers of them is abhorrent. Are there alternatives?

### **Alternative options**

#### *Translocation of complete herds of live animals*

The translocation of complete live herds is too expensive and impractical in the geographic situation of Kunene Region to be taken seriously. Slotow (*et al* 2008) state that “Culling in excess of the population growth rate is the only viable mechanism by which populations can be reduced in the short term ... because of the high cost of capture and translocation, and the increasing scarcity of receiving habitat, this is not a viable alternative to culling ...”. To this could be added that, even if adequate funds could be sourced, the bureaucratic delays which would inevitably accompany negotiations to move significant numbers of elephants would prejudice the situation even further.

#### *Deterrents*

The use of deterrents (e.g. chilli pepper preparations) to prevent elephants entering areas where they are not wanted is simply moving the problem from one place to another.



*Water supplies for elephants*

The provision of water supplies which elephants can make use of in the communal land, particularly along the boundary with the commercial farming area, might have a short-term ameliorating effect on the present problem (**Appendix 6**, page 59). It should certainly be tried as an experiment to answer the question whether water is the driving factor causing elephants to enter the commercial farming areas. However, there are more fundamental elephant population issues at stake here.

*Adapt farming systems*

The increase in numbers of domestic livestock in the communal lands in Kunene Region is a key factor reducing the resources available to elephants. Coughenour (*et al* 1985), in examining traditional pastoral systems in the Turkana region of north-west Kenya (where conditions are similar to the arid areas of the Kunene Region), found that the grazing strategies adopted by pastoralists were well adapted to the risks affecting survival in harsh, unpredictable environments. These strategies were aimed more at maintenance of the biomass of livestock rather than maximising production, efficiency and growth as in developed economies. They concluded that these pastoralist systems provided stability and sustainable productivity.

Behnke (*et al* 1993) argue that herd management in such variable environments must aim at responding to alternate periods of high and low productivity with an emphasis on exploiting environmental heterogeneity rather than attempting to manipulate the environment to maximise stability and uniformity.

The present farming systems in the commercial farming areas of Kunene Region could be criticised for their lack of flexibility to adapt to a situation fraught with uncertainties, largely driven by rainfall variability but also including such factors as the presence of elephants. The rigid constraints imposed by livestock farming based on paddocking systems and notions of long term carrying capacities may be ill-suited to optimum land use.<sup>38</sup>

OI Pejeta Ranch in the Laikipia district of Kenya manages a highly profitable cattle ranching enterprise in combination with wildlife which relies on a system of mobile cattle kraals.<sup>39</sup> The cattle are herded around the ranch to make best use of the available grazing and are kept in the kraals at night to protect them from large predators (lions, leopards and hyaenas). The cattle move in an environment with the full complement of large wild mammals present (including elephants) and there are very few incidents. The kraals may remain in one place for a week or longer and the resulting concentrations of cattle dung create nutrient 'hotspots' which benefit both the cattle and the wildlife (Cumming *pers.comm.* August 2009).

---

38. Frankie Robbertse (Farm Vryheid 267) in the Kamanjab farming district is one of a number of farmers who has had to abandon farming cattle in 'camps' (paddocked systems) because of the damage done by elephants to fences.

39. These kraals are no more than a number of 'screens' about 2 metres high and 6 metres long which are hooked together to form an enclosure which can be moved at any time.

There could be wide-ranging consequences in the Kamanjab farming area if such a system were to be adopted by a number of farmers. It would allow the removal of fences between farms and the formation of genuine conservancies where wildlife and cattle could be managed with the increasing benefits of larger scales.

Namibian cattle farmers might argue that veterinary restrictions would preclude such development – particularly the requirement to be able to trace all meat products back to their original source and to be able to guarantee foot-and-mouth disease-free status. There have been rapid advances in the international meat industry in the past few years where it has been found that if meat is de-boned under controlled processing conditions it presents very few disease threats. This is reducing the number of controls now demanded by importing countries in meat industries.

Barnes (2001) found that large scale commercial livestock systems in Ngamiland, Botswana operated at a financial loss (-4 pula/ hectare) despite having the highest gross incomes. In contrast, small scale traditional livestock management produced a net return of 26 pula/hectare even though its gross income was less than 5% of the large scale commercial systems.

This entire discussion so far on adapting farming systems has tended to reinforce the idea that cattle systems are likely to and should remain the primary form of land use. Cumming (2005) reviewed the *status quo* in the South-East Lowveld of Zimbabwe (which has an annual rainfall similar to the commercial farming area in Kunene Region). The situation has been reached that none of the current land uses practised in isolation are capable of meeting the livelihood needs of the lowveld population. Cumming's recommendations are given in full in **Appendix 7** (page 60) because they are totally relevant to the Kunene Region situation, including the need to diversify production systems, to escape the constraints set by depending on above-ground primary production and to move away from centralised prescriptions for land use, tenure and resource access rights.

#### *Change institutional and legal systems affecting elephants*

By far the most powerful option which could affect the numbers of elephants which will survive in the long term both in the communal lands and the commercial farming area of Kunene Region lies in radical changes to the present institutional and legal system under which elephant management and utilisation is administered in Namibia.

### **Institutional and Legal Issues**

Ultimately, this study is not about carrying capacity. It was shown in **Table 3** (page 11) that if there were no people in the communal lands or on the private farms the carrying capacity for elephants in Kunene Region exceeds 7,000 animals. To this might be added that if the people in Kunene Region were committed to wildlife management as the primary form of land use, the carrying capacity for elephants would still be about 7,000 animals. The reason it is not is because both communal land people and private land farmers do not see their future as one relying on wildlife and, hence, there is a massive investment in domestic livestock.

It was apparent on the field trip at the start of this study that both in communal land and on private land there is no evidence of a major shift in lifestyle to a land use based primarily on wildlife – notwithstanding the fact that all of the areas visited called themselves conservancies.

There is a wealth of evidence to show that land use based on wildlife management can produce higher returns than cattle farming (Barnes 2001, Martin 2003 & 2008b). Jansen (*et al* 1992) found that the return per unit of investment in wildlife increased as mean annual rainfall decreased: the reverse was true for investment in cattle farming. The reason many farmers won't make the investment in wildlife<sup>40</sup> is the lack of secure tenure over wild resources.

As long as elephants are treated as Specially Protected Species under Namibian law and as long as the State continues to set the quotas for their use and decide on the offtake of problem animals, people will not feel they have sufficient proprietorship over the resource to make a full commitment to its conservation.

I will defend strongly the rights of farmers to make their own choices regarding use of land – but Government can help people arrive at the best decisions by creating a level playing field. The rights a farmer enjoys over wildlife, either in a communal land conservancy or on private land, should be no different to those he/she enjoys over cattle. A resolution adopted at the IUCN World Conservation Congress in November 2008 makes clear the nature of institutions and rights which are required (**Appendix 8**, page 62).

## CITES

The constraints placed on trade in ivory and other elephant products under the CITES treaty are acting against the conservation of elephants in Namibia and are contrary to the provisions in Namibia's Constitution for sustainable use of natural resources and the improvement of the livelihoods of its citizens (NAM 1990, Article 95(i)).

In Namibia's Management Plan for Elephants (Martin 2004a, Background Study), which was adopted by the Minister of Environment and Tourism immediately prior to the last CITES Meeting,<sup>41</sup> are recommendations on the course Namibia should pursue in order to remove these negative influences on its national programme of conservation and development (**Appendix 9**, page 64).

Similar constraints limit the potential wealth which black rhino could generate for Namibia. Martin (2009, p47) outlines the steps needed to trade legally within the CITES system for Appendix I specimens.

---

40. One of the few Kamanjab farmers who derives his annual income entirely from wildlife management (John van der Westhuisen, Westfalen [245], *pers. comm.* Nov. 2008) estimated that when his ranch was managed under cattle farming it produced a gross income of about US\$50,000/year from 7,000ha. Under wildlife it is making between US\$120,000 -150,000/year.

41. Fourteenth Meeting of the Conference of the Parties to CITES, 3-15 June 2007, The Hague, Netherlands.

## RECOMMENDATIONS

No elephant population can expand indefinitely. It is difficult to grasp the concept that despite the apparently vast open spaces in the north-west of Namibia the elephant population has already exceeded a threshold where there are sufficient resources to maintain its numbers. The situation is not of the elephants' own making – as is the case in most 'elephant problems'. The Kunene Region elephants have had their effective range curtailed – the space is still there but the resources are not.

There are some short-term measures which could relieve the situation. They will not necessarily solve the problem in the long term.

### 1. Short-term measures

- (1) The provision of water for elephants, particularly along the boundary between the communal lands and commercial farming area in Kunene Region might limit the incursions into private land. Such measures have been tried already with little success and, unless the water supplies are designed on the lines described in **Appendix 6** (page 59), they are unlikely to work.
- (2) The adoption of a 'Source-Sink' management system within the Region will address the immediate crisis of elephants in areas where they are not wanted. One such 'sink' might be created in the Kamanjab farming area where elephants leaving Etosha and the communal lands and entering the farming area are destroyed <sup>42</sup> (**Fig. 14**).

Several other sinks might be created in the communal lands in areas of high population density for humans, livestock and elephants. For example, a sink might be created in #Khoadi-//Hoas conservancy adjacent to the commercial farming area; another centred on Anabeb and Omatendeka conservancies; and another in the communal lands west of Opuwo with high livestock concentrations.

As in the case of the commercial farming area, these sink areas should be identified by the communities themselves rather than selected by outsiders.

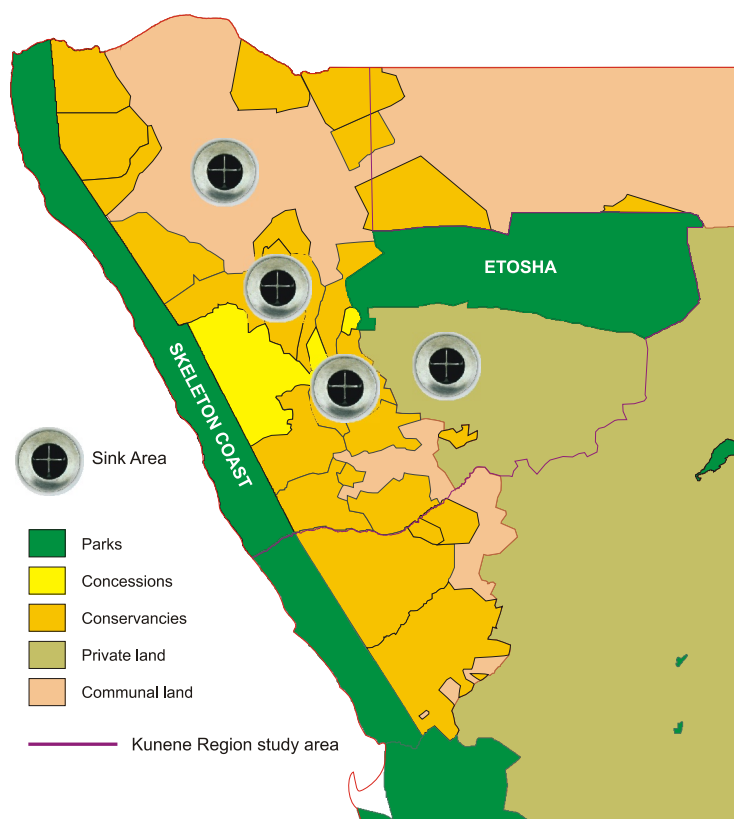

**Figure 14. Possible Sink Areas in the North-West**

42. The 'sink' need not entail the entire farming area but might be limited to a group of farms identified by the farmers themselves – probably including those farms on the boundary with the communal land.

As a general principle, large culls should be avoided in favour of an adaptive management system which continues the removal of elephants from sink areas over a period of years until there are no further incursions of elephants into the commercial farming area and those parts of the communal land where they are not wanted.

Management in the commercial farming areas and communal land conservancies should not be carried out by MET for several reasons: firstly, it would be a major drain on government resources because the task would require a full-time, on-the-ground presence of problem animal control staff; secondly, whatever these staff do it will be unlikely to satisfy farmers completely; thirdly, if the responsibility is placed completely with the farmers, they will have no grounds for any further complaints; and, lastly, if they are given the responsibility it is likely that they will find a solution which does not necessarily result in the deaths of all elephants entering the sink areas.

Such a system must go hand-in-hand with institutional development both in the commercial and communal land farming areas <sup>43</sup> –

- a. Conditional on government granting the farmers a mandate to handle the problem themselves, must be the submission of a plan by the farmers that provides the assurance that the system will be administered impartially and that the benefits from the elephants will accrue to all affected farmers. <sup>44</sup>
- b. The farmers must be given the full latitude to make best use of the elephants. This should include selling trophy bulls (but not females) when the opportunity arises. It should also include the right to translocate elephants if circumstances are favourable.
- c. All of the benefits from the population reductions (including ivory) should belong to the relevant conservancies or commercial farmers. <sup>45</sup>

- 
43. Martin (2009, Annexure 2) makes the point strongly that properly constituted communal resource management regimes are a form of private proprietorship. They are similar to collective private regimes but their membership and forms of governance are sufficiently different to merit a separate listing. Being located in communal land, they are under the eminent domain of the State – but even private regimes on private land are subject to the State’s continued indulgence. To remove communal regimes from the “private” category (which is where they belong) and place them under “communal lands” (a category of state-run land) perpetuates a terminologically engendered misconception.
  44. The existing conservancy in Kamanjab (Loxodonta Conservancy) would provide a suitable vehicle for co-ordinating the commercial farmers, provided that all farms were eligible to receive the benefits of elephant management (even if they were not members of the conservancy).
  45. The benefits must go the farmers rather than into any external fund. It is these benefits which may cause the farmers to review their approach to the problem. There is a potential conflict with the new HWC Policy (MET 2009, page 7) over the disposal of the benefits from elephant population control. Whilst endorsing the principle that local communities can use the products from problem animals, the policy makes a specific exception in the case of elephant, rhinoceros and hippo.

Were government to take such an approach, the results might end up surprising all stakeholders. Long before the full complement of elephants predicted under this study has been removed from the population, it is highly likely that the stakeholders will have found other solutions to the problem or modified the programme to produce greater benefits. But for this to work requires that they are given the authority to experiment with the programme. The outcome could easily be that a greater range is created for elephants in the north-west by communities agreeing amongst themselves on a zoning system for livestock and elephants.

- (3) The question of whether the elephant population in Etosha National Park should be reduced could be left in abeyance for the moment. This study has estimated the culling offtake needed to bring the Etosha elephant population down to a notional carrying capacity but, given the influence of rainfall, the carrying capacity cannot be stated with any certainty.

If the proposed source-sink management measures recommended for the north-west communal lands and the commercial farming areas do not solve the present human-wildlife conflict, then the elephant population in the Park must come under scrutiny. According to the simulation model used in this study, if there is emigration from Etosha, then a reduction in the Etosha elephant population will have a marked effect on the incursions of elephants into the commercial farming area (**Fig.11**, page 21). The essence of good adaptive management is that it is underpinned by hypotheses which are tested by implementation of management actions. Without such hypotheses, management becomes 'command-and control' (Holling & Meffe 1996) and little is learnt about the workings of the system.

In the present circumstances it may be difficult to diagnose whether the Etosha elephant population has exceeded carrying capacity. However, a reduction in the population carries lower risks than the alternative of no management. If the Etosha elephants are above carrying capacity, a reduction in their numbers will be beneficial for the habitats in the park and will reduce inter-specific competition. The same adaptive management approach should be used – if culling in Etosha reduces the incursions of elephants into the commercial farming area, a question will have been answered. Nothing will be learnt about the status of the elephant population under the 'No Management' scenario.

---

## 2. Longer term options

### (1) Institutional development

It is not intended to labour this point here. The institutional changes needed to provide local people with the incentives to make major changes in their land use and lifestyles were discussed on page 37. Suffice it to say that were government to adopt the recommendations above, it would be consistent with the new human-wildlife conflict policy (MET 2009) and would go a long way towards addressing the problem.

### (2) Intervention in land use

The problem in the commercial farming area of Kunene Region could be seen as lying in the geographic juxtaposition of two radically different forms of land use. Immediately adjacent to the major national park in Namibia is a farming area pursuing conventional domestic livestock farming.

In the 1950s in Zimbabwe, the area between Hwange National Park and the Victoria Falls (some 3,000km<sup>2</sup>) was developed for mixed farming and extensive cattle ranching (Child 1995: 134-135). This was done after a succession of good rainfall years and the expectations were that cattle ranching would produce high returns. The rainfall regime changed in the 1960s and the cattle farming became unprofitable. The entire area was expropriated by Government in 1970 because of land degradation under cattle and transformed into a State-run hunting area (Matetsi Safari Area) which soon became highly profitable.<sup>46</sup> Fair compensation was paid to all the dispossessed farmers and certain farmers committed to wildlife management remained as lessees on the land.

The Namibian government has the option of making a similar drastic intervention in the area south of Etosha National Park. This study is not advocating such an action and, were it to be done, would not recommend that the land became State Land. It could remain private land with a servitude imposed on the title deeds so that the land could only be used for wildlife management. As in the case of Matetsi, full compensation would need to be paid to farmers who chose not to remain. And to ensure that future wildlife regimes on the land were profitable, the transition would need to be accompanied by enabling provisions in the legislation which granted authority over wildlife and provided incentives for the future amalgamation of farms into major conservancies managed at suitable scales.

The ultimate aim of achieving improved land use and contributing significantly to the Namibian economy might be achievable without such drastic action simply by amending the present legislation to provide the enabling conditions – such as those listed elsewhere in the recommendations made in this section. The resulting outcome might be even better and more robust because it would have been built upon choice by the landholders themselves.

---

46. The loss from cattle ranching at that time was US\$0.85 cents/ha/year. After conversion to wildlife management, by 1981 the return became US\$3.70-US\$8.30/ha year.

### Carrying capacities for people in Kunene Region

In the recently completed Background Study on Black Rhino (Martin 2009), I used a relationship between human densities and rainfall in the communal lands based on Parker (1984) and Parker & Graham (1989) who presented data to show that wildlife disappears at human densities greater than 20 persons/km<sup>2</sup>. Most of their data applied to areas with annual rainfall above 500mm and I extrapolated their human density limit downwards to cover the rainfall range from 50-500mm per year. Using the adjusted densities, I calculated the minimum area required by the human populations in each conservancy.

I felt that the tenuous basis for this relationship was not good enough for the simulation model to examine the Kunene Region dynamics between people and elephants. I experimented with Sweet's (1998) rainfall model for estimating carrying capacity for livestock in Namibia. This was abandoned because it required too many assumptions – given the carrying capacities for livestock, it still required a knowledge of the average number of livestock units per household in the communal lands and the average number of people per household before it could be converted into a relationship between human densities and rainfall. Sweet's figures also appear unsustainable: he postulates carrying capacities as high as 4ha/LSU at a rainfall of 500mm/year and 20ha/LSU at a rainfall of 100mm/year. In the south-east Lowveld of Zimbabwe, which enjoys an annual rainfall of about 500mm, a stocking level of 10ha/LSU resulted in widespread degradation of the rangeland over 40 years and farmers reluctantly had to conclude that 20ha/LSU was more appropriate.

Ultimately I turned to the conservancies themselves to define the relationship. NACSO (2008) gives the areas and human population in each conservancy and I estimated the rainfall for

each conservancy from its centre in relation to the rainfall isohyets (**Fig.A1.1** opposite).

Whilst there are no absolute benchmarks to inform us of the extent to which each conservancy is approaching its carrying capacity for humans, the fact that elephants are having to emigrate from conservancies into commercial farms is an indicator that the overall carrying capacity of the communal land for elephants has been exceeded.

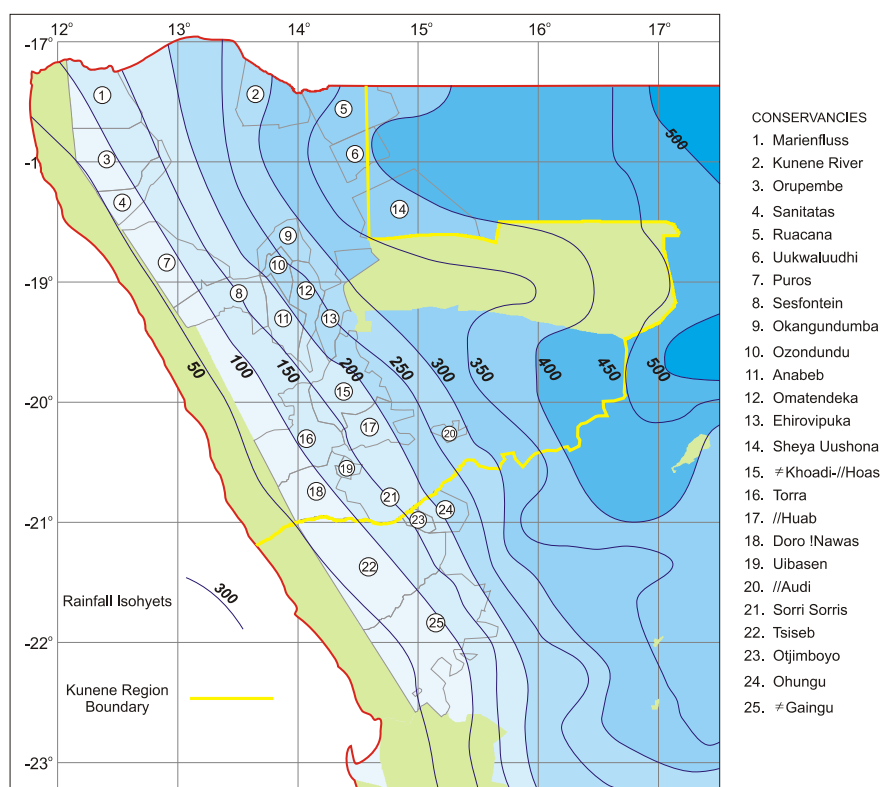

**Figure A1.1: NW Rainfall and conservancies**



The conservancies shown in Fig. A1.1 are listed in **Table A1.1** below together with their areas, rainfall and human populations. The human densities have been calculated and a curve fitted to the points shown in Fig. A1.2 with a numeric optimiser using the formula –

$$\text{Density} = A + B.e^{-C.Rainfall} \quad \text{persons/km}^2$$

– where the value of the constants which give the best fit are:  $A = 0.2$   $B = 0.11$   $C = 0.011$

**Table A1.1: Relationship between human densities and rainfall in the north-west**

Conservancies	Area km <sup>2</sup>	Numbers 2010	Rain mm	Density n/km <sup>2</sup>	Predicted n/km <sup>2</sup>
Tsiseb	8,083	2,000	80	0.25	0.47
≠Gaingu	7,677	2,800	80	0.36	0.47
Doro !Nawas	4,073	1,500	80	0.37	0.47
Puros	3,568	260	90	0.07	0.51
Orupembe	3,565	400	100	0.11	0.54
Torra	3,522	1,200	100	0.34	0.54
Sanitatas	1,446	250	110	0.17	0.58
Sesfontein	2,591	2,500	110	0.96	0.58
Marienfluss	3,034	300	120	0.10	0.63
Uibasen	286	230	130	0.80	0.68
Sorri Sorris	2,290	1,300	150	0.57	0.79
Otjimboyo	448	1,000	170	2.23	0.94
≠Khoadi-//Hoas	3,366	3,200	170	0.95	0.94
Anabeb	1,570	2,000	180	1.27	1.03
Omatendeka	1,619	2,500	200	1.54	1.23
//Huab	1,817	5,000	200	2.75	1.23
Ohungu	1,211	1,000	210	0.83	1.35
Ozondundu	745	2,000	230	2.68	1.64
Ehrovipuka	1,975	2,500	250	1.27	1.99
Okangundumba	1,131	2,500	260	2.21	2.20
//Audi	335	1,000	270	2.99	2.44
Kunene River	2,764	2,000	310	0.72	3.68
Ruacana	2,993	25,000	360	8.35	6.24
Sheya Uushona	5,066	35,400	380	6.99	7.73
Uukwaluudhi	1,437	25,000	400	17.40	9.60
Totals	66,612	122,840			

There is an additional area of 30,085km<sup>2</sup> of communal land within Kunene Region shown in **Fig.1** (page 6) where there were no registered conservancies in 2007. To be able to include this area in the simulation model, I calculated the areas in each of the rainfall bands and assigned a human population to each of these areas based on the average densities of people in the conservancies occurring within the same rainfall band.

I then experimented in the simulation model (described in **Appendix 2**, page 46) with four 'carrying capacity' curves for the people living in the north-west conservancies (**Fig.A1.2** below). The curve derived from the formula on the previous page is Curve 2 which results in roughly equal numbers of conservancies above and below the line. With small adjustments to the constants in the formula, it was possible to produce the other curves.

Curve 1 lies below all the data points and would indicate that all of the conservancies were above carrying capacity in the year 2007. It was easy to reject this curve because, in the simulation model, it results in far larger numbers of elephants emigrating before 1997-1998 than were reported by the Kamanjab farmers.

Curve 3 lies just above most of the data points and would represent the situation that none of the conservancies had reached carrying capacity in 2007 but would do so in the near future. This curve can also be rejected because it does not result in any elephant invasions of the Kamanjab farming area until well after the year 2007.

Curve 4 was chosen to represent the situation where all of the conservancies were a long way below carrying capacity in 2007. It can be rejected for the same reason as Curve 3.

Curve 2 (the fitted curve) results in incursions into the commercial farming area in 1997-98 but the numbers are considerably lower than have been reported by the farmers.

The curve which best fits the situation on the ground lies somewhere between Curve 1 and Curve 2. It depicts a scenario where about three-quarters of the conservancies were above human carrying capacity in 2007 and results in the emigration of elephants from the communal land in 1997-98 in numbers which are consistent with the Kamanjab farmers' personal experience.

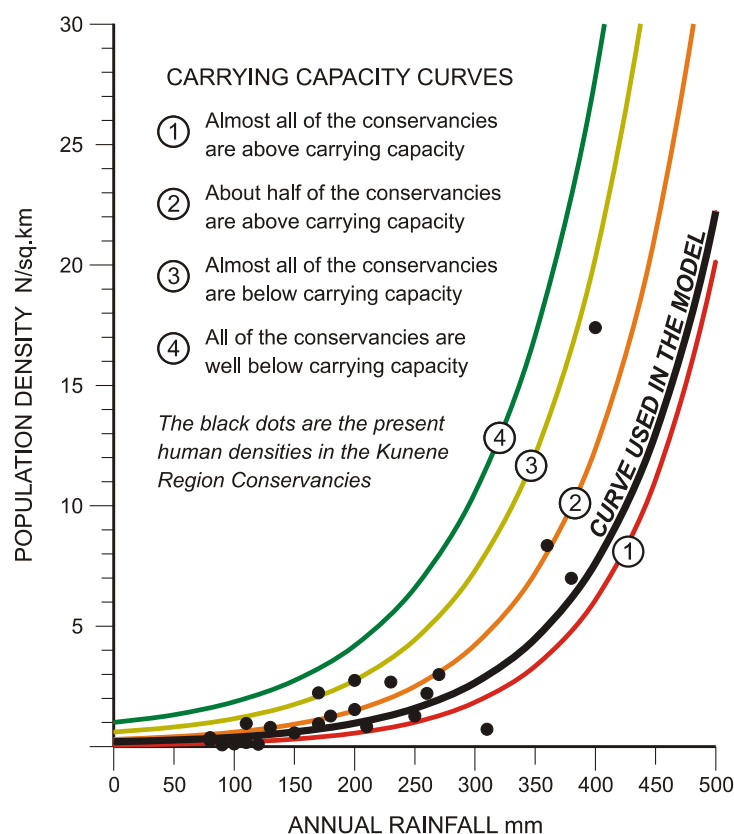

**Figure A1.2: Rainfall and human densities**

## APPENDIX 2

**Simulation of the Elephant Population in Kunene Region**(1) Initial conditions

The model begins in 1995, with human populations having been ‘back-calculated’ to their expected numbers in that year, and runs up to the year 2020, i.e. ten years from now.

Three numbers are preset at the start –

- (1) The Etosha elephant population (set at 2,000 elephants in 1995);
- (2) The north-west elephant population (set at 550 animals in 1995); and
- (3) The proportion of elephants which migrate from any area once carrying capacity in that area has been exceeded (set at 15% throughout the time period of the model).

These numbers can be altered in the model to test any hypothesis. The numbers given above come closest to meeting the constraints imposed by certain known benchmarks (see (3) below).

The proportion of elephants emigrating bears discussion ((1)c. above). In the early stages of developing the model, emigration was assumed to be instantaneous – once carrying capacity had been exceeded in any block of land, the entire surplus above carrying capacity emigrated. The model did not function realistically given this assumption – as each carrying capacity threshold was crossed, large population changes took place and it was impossible to produce something resembling the pattern of movements into the Kamanjab farming area.

A little reflection caused me to alter this condition. Elephants, even when there are no physical constraints limiting their movements, tend to remain where they are and ‘overshoot’ carrying capacity – they may become overpopulated in any given area for some time before any movements happen. When the movements do happen it is most unlikely that the entire population emigrates at once – usually a few males carry out reconnaissance forays and, some time afterwards, cow herds may follow. Setting a percentage which emigrates when carrying capacity has been exceeded allows overpopulation to take place (realistically) and, at the same time, gives the modeller some control over the emigrating numbers.

(2) How the model operates

The model is designed to run on any computer spreadsheet software. The areas appear as the rows in the spreadsheet, grouped into blocks starting with (a) Etosha National Park, (b) Skeleton Coast National Park and the communal land concessions, (c) the individual conservancies, (d) the ‘other’ communal land in four rainfall bands and, (e), the private farm land. The successive years are blocks of 6 columns at a time where the calculations described below take place.

The first six columns in the spreadsheet contain the essential information for each area in each row including its name, total area (km<sup>2</sup>), rainfall (mm), the area available for elephants in 1995, the stocking level for elephants (km<sup>2</sup>/elephant) and the annual rate of growth for elephants (%/year). The subsequent columns in the spreadsheet refer back to these six columns to calculate the annual population increase and the potential elephant population (**Table A2.1a**, page 49).

- (1) The first year of the model starts with the set elephant population from (1)a. above (**Table A2.1a**, page 49).
- (2) Breeding takes place at the start of the year (**Tables A2.1b & c**) with each individual area having a growth rate for elephants set by the rainfall value for the area (page 10).
- (3) The number of elephants above the Etosha carrying capacity is then calculated and the number which will emigrate is calculated from the percentage specified in (1)c.
- (4) The available area for elephants in each conservancy and each block of 'other' communal land is then calculated taking into account the increase in the human population since the previous year (this has already been done on a separate spreadsheet and the number is simply imported).
- (5) The potential elephant population in that block is calculated from the relevant stocking level for the given rainfall (Fig.4, page 10).
- (6) The total elephant population in the north-west at this stage, including the numbers which immigrated from Etosha in the previous year, is then re-allocated to those areas (conservancies, 'other' communal land, Skeleton Coast park and the communal land concessions) which still have land available for elephants. The allocation is done in the proportion which the potential elephant population in the relevant block forms of the total potential north-west elephant population in the year concerned.
- (7) If any area has been allocated more elephants than its potential elephant population, the surplus which will emigrate is calculated using the percentage specified in (1)c. This means that areas which still have available land for elephants will become overpopulated with elephants as the model progresses.
- (8) The elephants which will emigrate from the north-west in the year concerned are summed and it is assumed that 50% of these will enter the private farm land within Kunene Region. The remainder will emigrate to Erongo Region.<sup>47</sup>
- (9) The elephant population at the end of the year is then calculated by deducting the emigrating elephants from the allocated elephants. The cycle is then ready to repeat itself for the next year.

---

47. The boundary between communal land and private land within Kunene Region is approximately equal to the common boundary between Kunene Region and Erongo Region – hence the 50:50 split for emigrating elephants. Elephants are already present in significant numbers in Erongo Region in conservancies (e.g. Tsiseb, ≠Gaingu, Otjimboyo, Ohungu) and in the commercial farming districts of Omaruru. The invasions have gone further into the Kalkveld area in Otjozondupa Region.

### (3) Model constraints

Elsewhere in this report, I have noted how little data are available on current elephant numbers in the north-west. The few benchmarks which were available and which the model was required to reproduce are as follows –

- (1) The Etosha elephant population was required to remain between 2,000 and 2,500 animals for the period 1995-2009. By controlling emigration, it was possible to achieve this. The initial population was set at 2,000 animals ((1)a. above) and, in the year 2020, had reached some 2,400 animals with emigration rising to about 80 animals per year.
- (2) The north-west elephant population (i.e. the population outside Etosha) was required to lie between 400 and 700 animals for the period from 1995 to 2000 (**Fig.3**, page 8). Under the rules developed for elephant and human carrying capacities, a starting population of 550 animals ((1)b. on the previous page) met this condition. In **Tables A2.1a & A2.1b** on the following pages, the cells titled ‘DG estimate’ give the population values for 1995-1997.
- (3) The north-west population was required to increase annually at a growth rate between 3.5-9% per annum from 1995-1998. A starting population of 550 animals achieves this.
- (4) Significant incursions of elephant into the commercial farming area were required to begin in 1997-1998. The model produces about 20 animals per year in 1997-1998 with the selected carrying capacities for humans and elephants (**Table A2.1b**).

---

Excerpts from the model are presented in Tables A2.1a-c on the following pages. The entire model is too large to reproduce in this report (it would require about 20 pages). The changes in the elephant population over the years 1995-2020 are shown in **Fig.9** in the main report.

**Table A2.1a: Kunene Region simulation model – Start 1995**

Assumed elephant Etosha population 1995		<b>2,000</b>		NW population start 1995		<b>550</b>			
When a surplus, proportion of surplus leaving area		<b>15.0</b>		Percentage of surplus elephant to Kamanjab		<b>50</b>			
							<b>1995</b>		
<b>Parks &amp; Concessions</b>	Area km <sup>2</sup>	Rain mm	Area 2010	CC k m <sup>2</sup> /eleG	Rate of rowth%	Potential Number	<b>ACTUAL POP</b>	Number emigrating	Final pop
Etosha West	9,479	330	9,479	11.9	3.18	795	829	5	824
Etosha East	8,521	400	8,521	7.6	3.64	1,122	1,171	7	1163
	18,000					1,918	2,000	12	1988
							<i>DG Estimate</i> <b>490</b>		
							NW population start 1995 <b>550</b>		
							Surplus <b>0</b>		
	Area km <sup>2</sup>	Rain mm	Area 1995	CC k m <sup>2</sup> /eleG	Rate of rowth%	Potential Number	Model Allocn	Surplus	Final pop
Skeleton Coast	16,390	50	16,390	250.2	1.33	66	59	0	59
Palmwag	6,398	85	6,398	163.1	1.56	39	36	0	36
Etendeka	1,108	160	1,108	66.6	2.06	17	15	0	15
Hobatere	269	260	269	22.3	2.72	12	11	0	11
	24,165		24,165			133	121	0	121
<b>Conservancies</b>									
Marienfluss	3,034	120	2,555	106.9	1.79	24	22	0	22
Kunene River	2,764	310	2,259	14.0	3.05	161	146	0	146
Orupembe	3,565	100	2,811	136.0	1.66	21	19	0	19
Sanitatas	1,446	110	1,012	120.6	1.73	8	8	0	8
Ruacana	2,993	360	0	9.6	3.38	0	0	0	0
Uukwaluudhi	1,437	400	0	7.6	3.64	0	0	0	0
Puros	3,568	90	3,037	153.5	1.59	20	18	0	18
Sesfontein	2,591	110	0	120.6	1.73	0	0	0	0
Okangundumba	1,131	260	73	22.3	2.72	3	3	0	3
Ozondundu	745	230	0	30.4	2.52	0	0	0	0
Anabeb	1,570	180	0	52.9	2.19	0	0	0	0
Omatendeka	1,619	200	0	42.2	2.32	0	0	0	0
Ehrovipuka	1,975	250	804	24.7	2.65	33	30	0	30
Sheya Uushona	5,066	380	792	8.5	3.51	93	85	0	85
#Khoadi-//Hoas	3,366	170	94	59.3	2.12	2	1	0	1
Torra	3,522	100	1,260	136.0	1.66	9	8	0	8
//Huab	1,817	200	0	42.2	2.32	0	0	0	0
Doro !Nawas	4,073	80	766	173.4	1.53	4	4	0	4
Uibasen	286	130	0	94.9	1.86	0	0	0	0
//Audi	335	270	0	20.2	2.78	0	0	0	0
Sorri Sorris	2,290	150	693	74.9	1.99	9	8	0	8
	49,193		16,156			388	352	0	352
<b>Other Communal Land</b>									
	Area km <sup>2</sup>	Rain mm	Area 1995	CC k m <sup>2</sup> /eleG	Rate of rowth%	Potential Number	Model Allocn	Surplus	Final pop
Rainfall <100mm	393	50	145	250.2	1.33	1	1	0	1
Rainfall 100-200mm	9,812	150	2,236	74.9	1.99	30	27	0	27
Rainfall 200-300mm	12,970	250	620	24.7	2.65	25	23	0	23
Rainfall 300-400mm	6,909	350	300	10.3	3.31	29	27	0	27
	30,085		3,301			85	77	0	77
<b>Private Land – Kunene Region</b>									
Elephants invading private land							<b>0</b>		
Cumulative number invading							<b>0</b>		
<b>Total potential elephants 1995</b>							<b>4,975</b>		
Excluding Etosha and Private Land							<b>606</b>		
Communal land (excluding concessions)							<b>472</b>		
<b>Total Kunene Region Elephant Population</b>							<b>2,538</b>		
Excluding Etosha and Private Land							<b>550</b>		
Communal land (excluding concessions)							<b>429</b>		

Table A2.1b: Kunene Region simulation model – 1996-1997

1996					1997					
<b>Parks &amp; Concessions – Etosha</b>										
Starting pop	Potential Number	Model Number	Number emigrating	Final pop	Starting pop	Potential Number	Model Number	Number emigrating	Final pop	
851	795	851	8	842	869	795	869	11	858	
1,206	1,122	1,206	13	1,193	1237	1122	1237	17	1219	
2,056	1,918	2,056	21	2,035	2106	1918	2106	28	2077	
<i>DG Estimate</i> 520					<i>DG Estimate</i> 552					
NW population 576 including ENP emigration					NW population 608 incl. ENP emig.					
Rate of growth 4.8 % excluding surplus					Rate of growth 5.5 % excluding surplus					
<b>Rest</b>					<b>Rest</b>					
<i>Surplus</i> 3					<i>Surplus</i> 15					
Starting pop	Area left	Potential Number	Model Allocn	Final pop	Starting pop	Area left	Potential Number	Model Allocn	Final pop	
60	16,390	66	68	68	68	16,390	66	78	76	
36	6,398	39	41	40	41	6,398	39	47	46	
15	1,108	17	17	17	18	1,108	17	20	19	
11	269	12	13	12	13	269	12	14	14	
123	24,165	133	138	138	140	24,165	133	159	156	
<b>Conservancies</b>										
22	2,543	24	25	25	25	2,531	24	28	28	
151	2,246	160	166	165	170	2,233	159	190	186	
19	2,792	21	21	21	22	2,773	20	24	24	
8	1,001	8	9	9	9	990	8	10	10	
0	0	0	0	0	0	0	0	0	0	
0	0	0	0	0	0	0	0	0	0	
18	3,024	20	20	20	21	3,010	20	23	23	
0	0	0	0	0	0	0	0	0	0	
3	47	2	2	2	2	20	1	1	1	
0	0	0	0	0	0	0	0	0	0	
0	0	0	0	0	0	0	0	0	0	
0	0	0	0	0	0	0	0	0	0	
30	775	31	33	32	33	745	30	36	35	
88	685	81	84	83	86	575	68	81	79	
1	12	0	0	0	0	0	0	0	0	
9	1,204	9	9	9	9	1,146	8	10	10	
0	0	0	0	0	0	0	0	0	0	
4	683	4	4	4	4	599	3	4	4	
0	0	0	0	0	0	0	0	0	0	
0	0	0	0	0	0	0	0	0	0	
9	653	9	9	9	9	612	8	10	10	
362	15,665	369	382	380	391	15,234	350	418	408	
<b>Other Communal Land</b>										
Starting pop	Area left	Potential Number	Model Allocn	Final pop	Starting pop	Area left	Potential Number	Model Allocn	Final pop	
1	139	1	1	1	1	133	1	1	1	
28	2,047	27	28	28	29	1,853	25	30	29	
23	311	13	13	13	13	0	0	0	0	
27	135	13	14	14	14	0	0	0	0	
79	2,632	54	56	55	57	1,985	25	30	29	
<b>Private Land – Kunene Region</b>										
Elephants invading			2				7			
Cumulative number invading			2				9			
<b>1996</b>					<b>1997</b>					
4,925 ----- Total potential elephants -----					4,878					
556 ---- Excluding Etosha and Private Land ----					509					
422 – Communal land (excluding concessions) –					375					
<b>Total Kunene Region Elephant Population 2,610</b>					<b>Total Kunene Region Elephant Population 2,680</b>					
Excluding Etosha and Private Land 573					Excluding Etosha and Private Land 593					
Communal land (excluding concessions) 435					Communal land (excluding concessions) 438					

Table A2.1c: Kunene Region simulation model – 2010-2011

2010					2011					
<b>Parks &amp; Concessions – Etosha</b>										
Starting pop	Potential Number	Model Number	Number emigrating	Final pop	Starting pop	Potential Number	Model Number	Number emigrating	Final pop	
977	795	977	27	950	980	795	980	28	952	
1,421	1,122	1421	45	1,377	1,427	1,122	1,427	46	1,381	
2,398	1,918		72	2,326	2,406	1,918		73	2,333	
NW population <b>871</b> including ENP emigration					NW population <b>884</b> incl. ENP emig.					
Rate of growth 1.6 % excluding surplus					Rate of growth 1.5 % excluding surplus					
<b>Rest</b>					<b>Rest</b>					
Surplus <b>77</b>					Surplus <b>80</b>					
Starting pop	Area left	Potential Number	Model Allocn	Final pop	Starting pop	Area left	Potential Number	Model Allocn	Final pop	
144	16,390	66	160	146	148	16,390	66	164	149	
86	6,398	39	96	87	89	6,398	39	98	89	
37	1,108	17	41	37	38	1,108	17	42	38	
27	269	12	29	27	28	269	12	30	28	
294	24,165	133	326	297	302	24,165	133	335	304	
<b>Conservancies</b>										
49	2340	22	53	49	50	2323	22	54	50	
326	2033	145	354	323	332	2014	144	360	328	
40	2473	18	44	40	41	2446	18	45	41	
15	817	7	17	15	15	801	7	17	15	
0	0	0	0	0	0	0	0	0	0	
0	0	0	0	0	0	0	0	0	0	
40	2799	18	45	41	41	2780	18	45	41	
0	0	0	0	0	0	0	0	0	0	
0	0	0	0	0	0	0	0	0	0	
0	0	0	0	0	0	0	0	0	0	
0	0	0	0	0	0	0	0	0	0	
0	0	0	0	0	0	0	0	0	0	
29	280	11	28	25	26	237	10	24	22	
0	0	0	0	0	0	0	0	0	0	
0	0	0	0	0	0	0	0	0	0	
5	246	2	4	4	4	164	1	3	3	
0	0	0	0	0	0	0	0	0	0	
0	0	0	0	0	0	0	0	0	0	
0	0	0	0	0	0	0	0	0	0	
0	0	0	0	0	0	0	0	0	0	
0	0	0	0	0	0	0	0	0	0	
1	0	0	0	0	0	0	0	0	0	
506	1 0988	223	545	497	510	1 0765	219	549	499	
<b>Other Communal Land</b>										
Starting pop	Area left	Potential Number	Model Allocn	Final pop	Starting pop	Area left	Potential Number	Model Allocn	Final pop	
0	34	0	0	0	0	25	0	0	0	
0	0	0	0	0	0	0	0	0	0	
0	0	0	0	0	0	0	0	0	0	
0	0	0	0	0	0	0	0	0	0	
0	34	0	0	0	0	25	0	0	0	
<b>Private Land – Kunene Region</b>										
Elephants invading			<b>39</b>				<b>40</b>			
Cumulative number invading			<b>365</b>				<b>405</b>			
<b>1996</b>					<b>1997</b>					
<b>4,726</b> ----- Total potential elephants -----					<b>4,721</b>					
<b>357</b> ---- Excluding Etosha and Private Land ----					<b>352</b>					
<b>223</b> – Communal land (excluding concessions) –					<b>219</b>					
<b>Total Kunene Region Elephant Population 3,558</b>					<b>Total Kunene Region Elephant Population 3,631</b>					
Excluding Etosha and Private Land 794					Excluding Etosha and Private Land 804					
Communal land (excluding concessions) 497					Communal land (excluding concessions) 500					



## APPENDIX 3

**Reproductive Parameters and Population Simulation Model**

The biological parameters which determine the population dynamics of elephants are summarised in the table below. Sources of data include Craig (1984, 1992), Dunham (1988), Hanks (1972), Laws (*et al* 1975), Lindeque (1988), Martin (2004a) and Smithers (1983).

**Reproductive Parameters for Savanna Elephant**

Seasonal breeding	Most populations have a distinct breeding peak during the rainy season although births may occur in any month of the year
Gestation	22 months
Age at first conception	The median age is probably about 10 years old but in favourable conditions some females may conceive as early as 8 years of age. Laws ( <i>et al</i> 1975) recorded conception being delayed until 19 years of age in a high density population in Uganda.
Age at first parturition	In populations not suffering density-dependence effects, about 50% of the 12 year-old females will produce calves and by the age of 15 all females will have produced their first calves.
Fecundity (adults)	The effect of seasonal breeding results in most elephants producing a calf every four years throughout their life after their first parturition. Fecundity may decline in the last few years before death.
Longevity	Elephants are generally assumed to live to about 60 years old. On the basis of age criteria deficiencies, Craig (1992) considered it more likely that the age of senescence was about 50 years old.
Mortality (adult females)	Other than in times of environmental stress (drought or disease), natural mortality is very low – probably less than 0.5% per annum
Mortality (adult males)	Mortality is slightly higher than in females. Young males between the ages of 20-25 years have been recorded as suffering a higher mortality than the other adults in the population.
Mortality (juveniles)	Data on calf mortality are difficult to collect. Work on elephant life tables suggests that in normal conditions juvenile mortality does not exceed 10% in the first year of life.

**Fecundity:** Lindeque (1988) derived average fecundities for the female elephants in Etosha National Park in 1983 and 1985 from two shot samples which included 103 and 214 females respectively. His finding was that, over their main breeding life span, the females were producing almost exactly one calf every four years (i.e. a fecundity of 0.25 including calves of both sexes). In 1983 no animals under the age of 12 years were pregnant or lactating but in 1985 one quarter of the animals in the 9-12 year old age group were pregnant. An assumption of the model is that there will always be sufficient adult males with which to breed – an assumption which may not be satisfied if, for example, sport hunting quotas are too high. In this study a mean fecundity of 0.25 has been assumed for mature animals in Etosha and the age at first parturition has been spread across the age groups in the manner shown below –

Age	0 - 9	10	11	12	13	14	15	16 - 43	44	45	46	47	48	49	50
Fecundity	0	0.03	0.08	0.125	0.175	0.225	0.25	0.25	0.25	0.225	0.175	0.125	0.08	0.03	0

For compatibility with the elephant population growth rates used in **Appendix 2** (page 46), I have used a mean fecundity of 0.222 for mature animals in the arid areas.

**Mortality:** I use the term ‘central mortality’ to refer to the mortality during the main part of an elephant’s lifetime from 5-43 years old (see figure opposite). Age-specific mortality in the model is set by means of a ‘template’. It is only necessary to specify the central mortality for the population and the curves for juvenile mortality and senescence are adjusted automatically. In the example shown below, the mortality for each age class is derived by multiplying the number in the template by the central mortality of 0.5%. The mortality for males in the age classes 20-25 years is doubled.

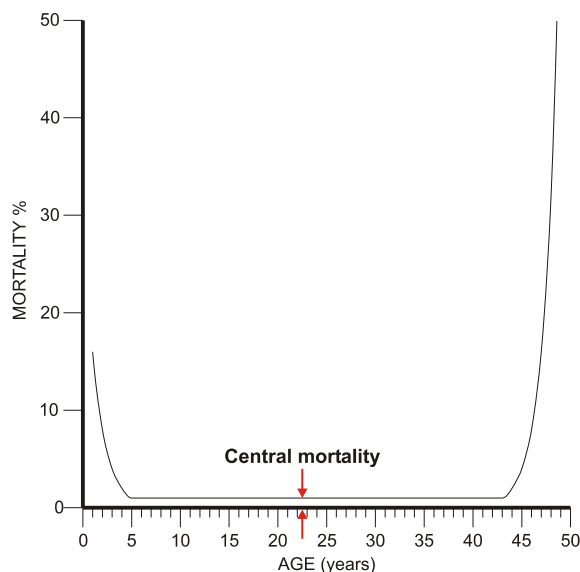

Age	1	2	3	4	5	6 - 42	43	44	45	46	47	48	49	50
Template	16	8	4	2	1	1	1	2	4	8	16	32	64	100
0.5%	8	4	2	1	0.5	0.5	0.5	1	2	4	8	16	32	50

Given the above fecundities and mortalities, the rate of growth for an elephant population with a stable age distribution is slightly less than 5%. If all mortality is set to zero (apart from the animals which die at the age of 50 years), the maximum growth rate rises to 5.7%. The various recorded cases in the literature where elephant populations appear to have increased at up to 7% per annum (e.g. Hall-Martin (1980) – Addo National Park) are invariably in situations where a stable age distribution has not been achieved. Although, in theory, a fecundity of one calf every 3 years is possible such a rate is likely to be an episodic event. Synchrony of calving among females following a drought could also give the effect of a very high rate of increase for a single year. However, averaged over four years the result is no different to that which would be obtained with a fecundity of 0.25.

In the tables below I examine the effect of natural mortality on an elephant population. The fecundities are as specified on the previous page and the mortality template is as shown above (i.e. juvenile mortality increases with the central mortality). Once natural mortality exceeds the threshold at which the population can maintain itself, it is of more interest to express the decline as a ‘half-life’ i.e. the time it take the population to halve.

**Response of an elephant population to changes in natural mortality**

**(a) Effects of changes in overall mortality on population growth rate**

Natural mortality %	0	0.25	0.5	0.75	1	1.25	1.5	2	2.25	2.5				
Rate of population growth %	5.70	5.11	4.56	3.99	3.42	2.84	2.26	1.09	0.00	Decline				
Half-life (years)	150	100	50	25	10	9	8	7	6	5	4	3	2	1
Natural mortality %	2.5	2.6	2.8	3.5	5.4	5.8	6.1	7.0	8.1	9.8	11.8	15.4	21.5	36.6

The effect of varying juvenile mortality independently of adult mortality is examined below. The specified mortality in the first row is for animals under one year old. Mortality is halved for each subsequent age class up to 5 years old. The adult mortality has been set at 1%.

**(b) Effects of changes in juvenile mortality on population growth rate**

Juvenile mortality %	5	10	15	20	25	30	35	40	45	50
Rate of population growth %	4.35	3.95	3.51	3.07	2.62	2.16	1.65	1.17	0.40	-0.12

It is apparent from table (b) above that an elephant population can tolerate very high levels of juvenile mortality – it is only when mortality reaches 50% that the population begins to decline. The same is not true for adult female survival. A mortality of more than 2.5% causes the population to decline.

The population simulation model is similar to that used in developing the Namibian Elephant Management Plan (Martin 2004a) which was refined in the Elephant Management Plan for Savé Valley Conservancy in Zimbabwe (Martin 2006) and has been further modified for this study. The model consists of 12 linked spreadsheets which operate as a ‘birth-pulse’ system. A single key-press causes the model to carry out all the calculations for one year and advance to the next year. The spreadsheets are as follows –

- A** – The main reproductive, management and financial parameters are defined here.
- B** – The **starting population** is defined here by setting the numbers in all male and female age classes. The model runs on a counter for each iteration and in the first year it uses the population defined here.<sup>48</sup> In all successive years, the ‘running cohort’ is the population from the year before (obtained after completion of the mortality calculations on spreadsheet **J**).
- C** – This sheet provides for density dependence and is not used in this application of the model.
- D** – The calculation of the annual **breeding** of the population is done here. Average female fecundities for each age class (see table at the bottom of page 52) are arranged in a row vector and multiplied by the numbers of females in each age class. The resulting vector is summed to give the total crop of calves which is then halved to give the numbers of male and female calves (the sex ratio at birth is assumed to be 1:1). The numbers in each age class of the existing vectors of males and females are then advanced by one cell (i.e. each animal ages by one year) and the new crop of calves is inserted in the first cell of each vector. This is the population at the start of the management year.

An additional section has been added to this sheet, when it used for simulating the north-west population outside Etosha, to provide for the immigration of elephants from Etosha. The immigration into the area outside Etosha takes place immediately after breeding in the model’s annual cycle. The formula which approximates very closely the Etosha emigration shown in **Fig.9** (page 16) is –

$$Emigration = 12.17 + 70 (1 - e^{-0.129 (Year - 1995)})$$

48. In the absence of any better information, I have assumed a stable age structure for the populations.

A difficulty arises when the number of animals emigrating in any particular year is small. If the animals are selected by applying a multiplier to the numbers in each class of the model, it results in the selected animals all coming from the age classes with the largest numbers, i.e. the juveniles in the population. To obviate this I introduced a set of rules: for fewer than 9 animals, it is assumed that all of the emigrating animals are males between the ages of 16-30 years; for 9-85 animals the population is grouped into 5 year age classes and the selection performed by using a multiplier on these grouped age classes; above 85 animals the numbers emigrating are large enough to resemble the overall age structure of the population and a multiplier can be used without producing atypical herds.

Five spreadsheets then follow, each dealing with a particular management activity. All of these spreadsheets contain algorithms which deal with the problem of small numbers in each age class and ensure that an integer number of animals is deducted from amongst the age classes. I use a ranking system to achieve this – where, for example, it is required to deduct 8 animals from the population, the model selects the eight animals closest to the required number.

**E** – The losses due to **illegal hunting** are calculated and subtracted from the population. This spreadsheet was not used in the simulations – it was assumed that illegal hunting was negligible in Kunene Region.

**F** – **Culling** entails the removal of animals in breeding herds (all males up to the age of 10 years and all females age classes). For males older than 10 years there is a probability less than unity which declines with age of their inclusion in the numbers culled. This sheet allows the specification of either a percentage offtake, or a fixed number from the population, or the surplus above a specified carrying capacity to be removed in any selected year. This last option was used in these simulations.

Provision is made for a specified number calves between the ages of 3-10 years to be captured and sold as live animals as part of the culling operation.

Another modification to the original model was introduced here: a provision for the emigration of surplus animals above carrying capacity in years when there is no culling. The algorithms governing this are the same as those described at the top of this page.

**G** – This sheet handles the **live capture** of elephant herds. Males older 30 years are excluded. The facility has not been used in this study.

**H** – **Problem animal control (PAC)** includes males and females older than 14 years of age. This sheet has also not been used in this study as the numbers of elephants killed as problem animals in Kunene Region is very low.

**I** – **Sport hunting**: It is assumed that only males aged 30 years and upwards will be hunted. The sheet allows for specification of a percentage offtake, or a set of percentage offtakes specified as part of ‘hunting regime’ or automatic quota setting through the control system defined on Sheet **R**. Mean tusk weights from the hunting offtake are calculated from age-specific allometric schedules.

This completes the spreadsheets analysing the management regime. For each sheet the total amount of meat, skin and ivory generated is calculated and costed.

**J** – **Natural mortality** is the last of the spreadsheets on which population numbers are modified in the course of an annual cycle. The mortality schedules are as specified earlier in this Appendix and the analysis is performed simply by multiplying the numbers in each age class by the age-specific mortality in row vector operation. However, elaborate precautions are taken to handle the small numbers problem, i.e. if a total of 5 animals is required to die, the algorithms ensure that this number is taken from the full range of age classes.

This sheet also calculates the total amount and value of ivory expected to be recovered from animals dying naturally.

After natural mortality has been applied, the final population vectors (males and females) become the starting population for the next year.

**K** – This sheet summarises each year of management giving the numbers at the start of the year, the numbers of animals dying in each category of management and through natural mortality, and the population at the end of the year. The population growth rate is calculated and the results are graphically displayed.

The spreadsheet software is set to ‘manual operation’, and the model is advanced one year at a time by a keypress. By keeping the key depressed, the model will run continuously within the speed limitations of the computer. Any particular run of the model is terminated on this page by the Reset button.

**L** – This sheet keeps an overall record of the results for each year in any run of the model, including all of the population dynamics information, the management information (offtakes, mean tusk weights etc.) and a full financial record of all gross and net income earned from management.

**M** – This sheet performs automatic hunting quota setting (**Appendix 4**, page 57).

---

## APPENDIX 4

**Automatic Setting of Quotas for Elephant Trophy Hunting**

The system applied to the setting of hunting quotas in this study is based on Martin (2006 & 2008a). The method is based on a classic engineering control system. The parameter controlled is the mean tusk weight of trophies and this is also the variable on which the control function is based. The quota setting function is –

$$F = A \cdot \varepsilon + B \cdot \frac{d\varepsilon}{dt} + C \cdot \int \varepsilon \cdot dt \dots\dots\dots \textcircled{1}$$

where –  $\varepsilon$  is the difference between the actual mean tusk weight and the desired mean tusk weight averaged over all of the hunting trophies in any given hunting season  
and  $A$ ,  $B$  and  $C$  are constants

This function is used to set the quota  $Q_i$  in any given year as follows –

$$Q_i = G \cdot F_{i-1} \dots\dots\dots \textcircled{2}$$

where –  $G$  is a constant (the “gain” of the system); and

$F_{i-1}$  is the value of the transfer function derived from the previous year

If the value of  $F_{i-1}$  is such that it would result in a negative quota, a logical condition is used to limit the value of  $Q_i$  to 0.05%.

The system is arithmetically simple to apply. Three columns are set up and, in the first, the error is tabulated – i.e. the difference between the desired mean tusk weight and the actual mean tusk weight for the year concerned. In the second the derivative is calculated. Because the minimum time interval for the population modelling (and quota setting) is one year, the term  $dt$  in the derivative can be ignored and the value required is simply the difference between the last year’s error and the present year’s error. Of course there is no value for the derivative in the first year of the exercise because the slope of the curve can only be determined from two data values. In the third column the integral is simply the cumulated sum of all errors to date.

The three terms are added together in a fourth column using the constants  $A$ ,  $B$  and  $C$  shown in formula  $\textcircled{1}$  above. In a fifth column the quota for the next year is set using formula  $\textcircled{2}$ . When hunting is combined with culling, the control system performs slightly better when the gain of the system (Constant  $G$ ) is allowed to increase in the early years after the start of culling in order to accommodate the major changes which occur in the population age structure.

## APPENDIX 5

**Farms Visited by Elephants in the Kamanjab-Outjo Commercial Farming Area**

The list of farms given below was updated in December 2008 during the field visit of this study. Farms shaded in grey have resident elephants. Farms in blue font derive their primary income from wildlife. Because of the difficulties I have experienced in trying to locate individual farms on the standard maps, I have grouped the farms below into three blocks. Each block begins with the most north-westerly farm in the block and the list runs row-wise southwards, ending with the most south-easterly farm.

#	Farm No	Farm Name	#	Farm No	Farm Name	#	Farm No	Farm Name
<i>W of Kamanjab-Khorixas road</i>			<i>N of Kamanjab-Outjo road</i>			<i>S of Kamanjab-Outjo road</i>		
1	626	Wildeck	34	190	Ondaura	58	258	Graniet
2	627	Arendsnes	35	255	Masuren	59	<b>29</b>	<b>Ureis Ekango</b>
3	628	Blyerus	36	254	Sendling	60	<b>259</b>	<b>Eensaamheid</b>
4	629	Voorspoed	37	253	Dankbaar	61	<b>259a</b>	<b>Picolo</b>
5	630	Gelbingen	38	286	Winkelhaak	62	<b>262</b>	<b>Stienie</b>
6	616	Ombonde.	39	293	Weltevrede	63	<b>262a</b>	<b>Safari</b>
7	615	Wilhelmsville	40	292	Bergtoppe	64	<b>28</b>	<b>Hirabis Sud</b>
8	608	Sonnegroet	41	295	Dorsland	65	<b>27</b>	<b>Khairos</b>
9	192	Weissbrunn	42	297	Olifantshoek	66	25	Otjitambi
10	605	Welvaart	43	298	Mon Desir	67	41	Hohenfels
11	604	Bergvallei	44	299	Morester	68	317	Heila
12	614	Bruno	45	294	Welkom	69	<b>260</b>	<b>Olifantsdood</b>
13	609	Grasheuwels	46	300	Truidia	70	<b>261</b>	<b>Huab</b>
14	241	Merrenu	47	256	Beulah	71	20	Gross Omaruru
15	242	Franken.	48	257	Kalkrand	72	<b>984</b>	<b>Erongo GR</b>
16	603	Geboortereg	49	<b>30</b>	<b>Cauas Okawa</b>	73	16	Schwarzenstein
17	210	Vierannas	50	31	Hirabis			
18	266	Vergelee.	51	243	Lusthof			
19	267	Vryheid	52	244	Gruis			
20	269	Amkarub.	53	246	Sydbury			
21	268	<b>Blydskap</b>	54	247	Amalinda			
22	273	Hoas	55	245	<b>Westfalen</b>			
23	374	Alettasrus	56	<b>245a</b>	<b>Klein Westfalen</b>			
24	540	Alettasrus Oos	57	124	Aimeb			
25	263	Paderborn						
26	188	Garubib						
27	264	Sebra.						
28	12	Mooipoort.						
29	209	Ehobib						
30	211	Krenzhof						
31	275	Twyfel						
32	878	Groot Weerlig						
33	419	Orpheus						

## APPENDIX 6

**Water Supplies for Elephants**

The drinking trough for elephants shown in **Fig.A6.1** was constructed by Mr. Karel Kruger of Bruno Farm (Kamanjab 614) on Condor Pos (617) in the ≠Khoadi-//Hoas Conservancy. Bruno farm borders onto the communal land opposite Condor and Emmanuel (613). We visited the site together in November 2009.

The water is contained in an underground tank about 3m long, 1m wide and 1.5m deep. The tank is covered with a concrete slab into which are set 6 large steel pipes about 30cm in diameter. Elephants can insert their trunks into the pipes and reach the water in the tank but cattle are unable to drink from it. At the time of the visit the water tank was empty despite an arrangement made with the nearby agricultural extension office to pump water into the tank on a regular basis.

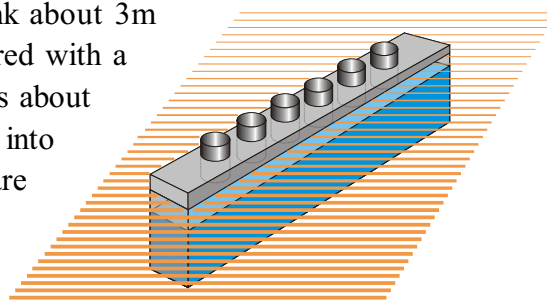

**Figure A6.1: Elephant drinking trough**

In the course of interviews held with local communities on Emmanuel and Condor we learnt that diesel was in short supply and that priority was given to providing water for domestic livestock. The people were adamant that they received no benefits from elephants or compensation for damage inflicted by them.

Chris Eyre (*pers.comm.* December 2008), working for IRDNC, is constructing water supplies for elephants and cattle in the Opuwo area. These are large robust reservoirs receiving up to 24,000 litres of water daily. Both elephants and cattle are able to drink from them but the cattle are unable to drink all of the water due to the height of the retaining wall – which ensures a permanent supply for elephants. The water is supplied by submersible pumps which are driven by solar energy and there are no attempts by elephant to interfere with the installations. Theft of solar panels has occurred but a new protected structure for supporting the solar panels appears to have solved the problem.<sup>49</sup>

The sites for these installations have to be carefully chosen. The performance of the submersible pumps declines the further they are situated below ground surface level and the maximum depth for worthwhile returns is about 15 metres.

These water supplies appear to have solved most of the problems encountered in attempting to provide water for elephants – particularly that of using diesel for conventional motor-driven pumps. Solar power seems a logical solution to providing energy in remote areas. These installations should have a wide application in the remote areas of Kunene Region.

---

49. I was advised that a theft of solar panels had occurred in September 2009 notwithstanding the improved protection of the installation.



## APPENDIX 7

**Wildlife, Livestock and Food Security in the South East Lowveld of Zimbabwe**

Extract from Cumming D.H.M. (2005)

**DISCUSSION**

The population to resource ratio in the South East Lowveld (SEL) of Zimbabwe is such that the natural resource base is not able to support the present population either through agropastoralism, wildlife production, or both. The human population in the SEL, particularly in the Communal Lands, is able to subsist through subsidies delivered to the region in the form of returns from off-farm labour supplemented by direct food aid in most years since the early 1980s. An essentially similar conclusion was reached by Campbell *et al.* (2002) following a long-term intensive study of livelihoods and production systems in the Chivi Communal Land, which is also in southeastern Zimbabwe but above the 600m contour. The population to resources ratio and the associated food security problem is also unlikely to be solved by small, incremental improvements in crop and livestock production in the Communal Lands of the region.

The bleak conclusion that existing land-use practice and policy is unlikely to resolve the problem raises the issue of what might mitigate the current problems of endemic food and environmental insecurity. In these circumstances, land tenure reform is frequently seen as a primary requirement. The current land reform programme initiated in Zimbabwe in 2000, ostensibly to decongest the Communal Lands, has had little impact on livelihoods and, if anything, has exacerbated the food security problem. Tourism has all but collapsed, production from irrigated estates has been disrupted, resettled farmers have lacked the inputs and resources to use newly settled land productively, and outbreaks of diseases such as FMD and anthrax have affected both livestock and wildlife production. Land tenure reform since 2000 has taken the form of transferring freehold land to state and leasehold land and, as Murombedzi and Gomera (2004) argue, this route is unlikely to attract investment and result in the productive use of the land in the long term.

What land-use strategies might then be adopted to mitigate the present dilemma? I suggest that the following four strategic approaches to land use and development would be appropriate.

1. *Place a premium on, and invest in, higher valued land uses and diversification.* There are many areas of irrigable soil in the SEL that merit development and others where irrigation schemes have collapsed or are underutilized. Developing potential intensive production areas in concert with appropriate livestock development would go a long way towards alleviating food shortages and unemployment. Associated investments in infrastructure to facilitate marketing of goods and services would be necessary.
2. *Decouple wealth creation from net above-ground primary production.* Because primary production in the SEL is so greatly limited by rainfall, the more wealth creation can be decoupled from a direct reliance of primary and secondary production, the less susceptible it will be to annual seasonal fluctuations in rainfall. One means of achieving this end is to develop high-valued tourism ventures in which the value is derived from services instead of from crop and meat production.

3. *Match land use and ecological process scales.* In arid areas, livestock and wildlife production systems generally require large areas over which to exploit temporal and spatial variations in the availability of key resources. Fragmentation of large landscapes by fencing and inappropriate land tenure systems and systems of resource access rights militate against adaptive strategies that may be more productive and sustainable in arid areas. The development of large-scale wildlife conservancies involving the effective amalgamation of former cattle ranches into large-scale wildlife tourism areas is a case in point (e.g. du Toit 1992).
  4. *Develop legal and policy frameworks that enable local-level innovation and adaptability in resource access rights and management strategies.* Current centralized prescriptions over land use, tenure, and resource access rights effectively stifle innovation and the development of adaptive co-management regimes at larger scales and across land tenure categories. It is suggested that releasing the innovative capacities of farmers, resource managers, and communities may go a long way towards solving the food and environmental security problems of the SEL.
-

## APPENDIX 8

**Resolution CGR4.MOT069 adopted by the World Conservation Congress  
held in Barcelona, Spain 5-14th October 2008****Empowering local communities to conserve and manage natural resources in Africa**

RECOGNIZING that local people have been managing their natural resources for millennia as an essential part of their livelihoods;

OBSERVING that many natural resource policies of the last century undermined the rights of communities to manage and benefit from their environments;

ACKNOWLEDGING that independent African governments have gone some way towards redressing this situation through “Community-Based Natural Resource Management Programmes” which grant limited rights of access to local resources;

CONCERNED that these measures have not gone far enough to restore the essential rights needed to develop the adaptability and resilience of local communities in the face of new emerging threats such as climate change, food shortages and pan-African human and animal health pandemics;

NOTING that robust management institutions can only be realized, and that economic incentives for sustainable natural resource management are only likely to be optimized, when people have full authority and responsibility for their resources;

EMPHASISING that the strengthening of these rights is a pre-requisite for local peoples to adapt and survive the growing crisis affecting Africa; and

RECALLING Res 3.012 (*Governance of natural resources for conservation and sustainable development*) adopted by the 3rd Session of the World Conservation Congress, which “urges IUCN to serve in a leadership role in relation to governance of natural resources for conservation and sustainable development”;

***The World Conservation Congress at its 4th Session in Barcelona, Spain, 5–14 October 2008:***

1. CALLS on African governments to confer legal rights on local people to:
  - a. Establish institutions for communal conservation and management of natural resources; and
  - b. Define the structure and membership of such institutions;
2. CALLS on local communities or collectives in Africa to establish institutions to conserve and manage the natural resources on which they depend for their security;

3. URGES local institutions in Africa established to conserve and manage natural resources to be given the authority and responsibility, *inter alia*, to:
  - a. Take all necessary measures to protect their natural resources;
  - b. Take all decisions on use of local resources and collaborate with neighbouring institutions when issues of scale demand a wider consideration;
  - c. Retain all income and non-monetary benefits from their management; and
  - d. Decide on the distribution of all income and benefits from their management; and
4. URGES all interested IUCN members to:
  - a. Advocate the case for such rights to be granted to local peoples and to assist governments with the legal basis for conferring such rights; and
  - b. When requested by local communities, to advise and assist them to establish institutions to manage and conserve the natural resources on which they depend for their security;

**In addition, the World Conservation Congress, at its 4th Session in Barcelona, Spain, 5–14 October 2008, provides the following guidance in the implementation of the Programme 2009–2012:**

1. CALLS on the Director General, where practicable and within the parameters of the programme, to advise and assist communities wishing assistance to establish institutions to conserve and manage natural resources; and
2. URGES all IUCN Commission members to advise and assist communities wishing assistance to establish institutions to conserve and manage natural resources.

Sponsors:

Resource Africa  
Namibia Nature Foundation  
CAMPFIRE Association  
Society for the Protection of Nature in Lebanon  
East African Wildlife Society

---

## APPENDIX 9

**CITES, ELEPHANTS AND NAMIBIA**

Extract from Namibia's Management Plan for Elephants (Background Study p47-48)

This section is concluded with a brief discussion on CITES matters affecting elephant. The calculations in this study of the financial values involving ivory and elephant skin have been done under the assumption that global markets for these products are operating normally – which is not the case. Although the Namibian elephant population is listed on Appendix II of CITES and, under the Articles of the Convention, trade in ivory and other elephant products should be possible with a minimum of bureaucratic interference, “*the Conference of the Parties has . . . adopted increasingly complex requirements for trade in elephant products that have all but ensured that such trade does not take place*” (MET 2004).

In a sense, these constraints which go beyond the provisions of the original Articles of the treaty are *ultra vires* – they impose conditions beyond those which were in place at the time a Party acceded to the treaty. However, there is little that any individual Party can do about it if such ‘annotations’ are adopted by a majority vote. Under the provisions of paragraph 1 of Article XXIII, a Party may enter a reservation against an annotation such as that which affects trade in elephant specimens but such a reservation must be entered within 90 days of the listing of a species on Appendix I or II or the transfer of a species between Appendices – a procedure which was not followed after the Namibian elephant population was transferred to Appendix II in 1997. The proliferation of annotations which go beyond the provisions of the Articles is a clear indicator that the original Treaty is deficient.

This leaves Namibia with three options. The first is to accept the *status quo*. The second is to proceed with trade in elephant products disregarding the annotation. The third is to denounce the treaty.

The perspectives included in Namibia's submission to the 13th CITES meeting to amend the annotation affecting Namibian elephants (MET 2004) are extremely powerful. They provide cogent reasons why the constraints on trade are acting against conservation in Namibia. The presentation ‘*Elephants and People*’ which was distributed to all CITES Parties (Martin 2004b) reiterates Namibia's determination to oppose measures imposed externally which act detrimentally on local people and national development aspirations. Namibia should reject the first option.

If Namibia were able to find willing partners to trade in ivory and other elephant products and followed the procedures of Article IV for trade in specimens of species included in Appendix II, there is very little that the CITES Parties or the Secretariat could do about it.<sup>50</sup> It requires only that an export permit is issued which meets the conditions that the Namibian Scientific Authority advises that the export will not be detrimental to the survival of the species and that the Namibian Management Authority is satisfied that the specimen was obtained in conformity with the laws of Namibia. There are no conditions for importing Party to satisfy. If Namibia were to pursue this option, there should be nothing clandestine about the action. In the end it will serve the same purpose as the last option.

---

50. This advice is from the respected leader of the CITES delegation of the Depository Government (Switzerland).

Namibia has considered withdrawing from CITES. This is perhaps the most powerful way Namibia could express its frustrations with the treaty and, if it is accompanied by a strong statement from the highest political level, it should cause many CITES Parties to take notice. When a country denounces CITES because it believes the treaty is acting against conservation, it will attract world wide publicity.

It is unlikely that Namibia would be able to remain outside CITES for very long: there will be a succession of representatives from the most powerful nations of the world and the CITES Secretariat beating a path to the door of the Minister of the Environment. Pressures on Namibia will be considerable, ranging from intense cajolery to direct threats affecting the delivery of international assistance. International NGOs will inflame the global media to cast Namibia in the worst light possible and it will be essential that the Namibian authorities ensure that their arguments are consistent and watertight. The best strategy may be one of total surprise. A comprehensive statement should be released at the time the denunciation is submitted to the Depositary Government and the Namibian authorities should enter into a minimum of public debate following this.

When Namibia is forced to re-accede to the Treaty, it will do so under an enhanced status. Its proposals for amendments of annotations should find ready acceptance.

---

## REFERENCES

- Avis, Japie (2003a). **Elephant Infiltration**. Letter from the Secretary of the Otjikondo Farmers Union to Director of Dept. Of Nature Conservation & Tourism dated 17 Feb 2003 referring to letter of 30 Sept 1997 and a workshop held in Grootberg, Damaraland in Sept 1999 where a petition on the elephant problem was handed over by the Farmers Association.
- Avis, Japie (2003b). **To whom it may concern**. General letter from Secretary of the Otjikondo Farmers Union dated 23 April 2003, commenting on a research proposal by Dr. Keith Leggett and concluding that the only solution to the elephant problem is that “the elephant herds must be reduced in number so that they can survive in their area of origin without destruction of their natural habitat.”
- Barnes, Jonathan, James Cannon and Karl Morrison (2001). **Economic Returns to selected Land Uses in Ngamiland, Botswana**. Consultancy for Conservation International. 60pp + Appendices
- Barnes J.I. (2009). **Financial/economic Model - Commercial Beef Breeding and Rearing - (Etosha Area) Savanna Biome - Base Case. Table 16: Summary of Results**. Excel Spreadsheet kindly provided by the author from work in progress on an analysis of Commercial Beef Breeding and Rearing.
- Behnke Roy.H.Jr, Ian Scoones & Carol Kerven [Eds](1993). **Range Ecology at Disequilibrium: New Models of Natural Variability and Pastoral Adaptation in African Savannas**. Publ. Overseas Development Institute, London. 248pp
- Campbell B.M., S. Jeffrey, W. Kozanayi, M. Lukert, M. Mutamba & C. Zindi (2002). **Household livelihoods in semi-arid regions: options and constraints**. Publ. CIFOR, Bogor, Indonesia, 2002.
- Child G.F.T. (1995). **Wildlife and People: the Zimbabwean Success. How the conflict between animals and people became progress for both**. WISDOM FOUNDATION, Harare and New York. 267pp
- Coughenour, M.B., J.E. Ellis, D.M. Swift, D.L. Coppock, K.Galvin, J.T. McCabe & T.C. Hart (1985). **Energy Extraction and Use in a Nomadic Pastoral Ecosystem**. Science **230** (4726): 619-625
- Craig, G.C. (1984). **Foetal mass and date of conception in African elephants: a revised formula**. S. Afr. J. Sci. 80: 512-516
- Craig G.C (1992). **A simple model of elephant/tree equilibrium**. Appendix 10 in *Elephant management in Zimbabwe*. Eds R.B. Martin, G.C. Craig, V.R. Booth and A.M.G. Conybeare. Department of National Parks and Wild Life Management, Zimbabwe. 124pp
- Craig G.C. (2001) **The MET’s Aerial Surveys of Wildlife in North-western Namibia**. Appendix III in Gibson D.St.C (Ed. 2001).
- Cumming D.H.M. (2005). **Wildlife, Livestock and Food Security in the South East Lowveld of Zimbabwe**. In: *Conservation and Development Interventions at the Wildlife/Livestock Interface: Implications for Wildlife, Livestock and Human Health*. Eds. S.A. Osofsky, S. Cleveland, W.B. Karesh., M.D. Kock, P.J. Nyhus, L. Starr & A. Yang. Occasional Paper No.30 of the IUCN Species Survival Commission, IUCN, Gland, Switzerland and Cambridge, UK.
- Cumming D.H.M.(2007). **Of elephants, predators and plants in protected areas: a case of classic trophic cascades**. Presentation in the Symposium *Sharing the range: Elephants, people and biological conservation in Africa* at the 21<sup>st</sup> Annual Meeting of the Society for Conservation Biology titled *One World, One Conservation, One Partnership* held at the Nelson Mandela Metropole in Port Elizabeth, South Africa, July 2007.

- DSS (2002). **Aerial Survey Summary (1968 - 2001)**. Compiler: Uatjavi Uanivi, Directorate of Scientific Services, Ministry of Environment and Tourism, Republic of Namibia. 54pp
- Dunham K.M. (1988). **Demographic changes in the Zambezi Valley elephants (*Loxodonta africana*)**. J. Zool. 215: 382-388
- du Toit R.F. (1992). **Large-scale wildlife conservancies in Zimbabwe: Opportunities for commercial conservation of endangered species**. In: *Wildlife Ranching: A Celebration of Diversity*. W. Van Hoven, H. Ebides & A. Conroy [Eds], South African Game Organisation, Pretoria: 295-300
- Fox, Betsy & Hu. Berry (1999). **Problem Elephant Management Options for the Kunene & Erongo Regions**. Draft document summarising the outcome of workshops held in NW Namibia Sept-Nov 1999 to address elephant problems. 10pp
- Gibson D.St.C (Ed. 2001). **Wildlife Monitoring in North-Western Namibia**. Consultancy done for WWF LIFE in Namibia. Main document 17pp + History and Analyses + Appendices 37pp
- Hanks J. (1972). **Reproduction of elephant, *Loxodonta africana*, in the Luangwa Valley, Zambia**. J. Reprod. Fert. 30:13-26
- HINNAM (2008). **Health in Namibia: Progress and Challenges (2001)**. An overview of health services, modern diseases, the country's demography and some of the challenges that lie ahead. Study compiled for the Ministry of Health and Social Services by S. El Obeid, J.M. Mendelsohn, M. Lejars, N. Forster & G. Brulé, Published by RAISON, Windhoek.
- Holling C.S. (2001). **Understanding the Complexity of Economic, Ecological, and Social Systems**. Ecosystems 4: 390-405
- Holling C.S. & Gary K. Meffe (1996). **Command and Control and the Pathology of Natural Resource Management**. Conservation Biology 10(2); pp328-337
- Jansen D.J., B. Child & I. Bond (1992). **Cattle, wildlife both or neither: Results of a financial and economic survey of commercial ranches in southern Zimbabwe**. WWF Multispecies Project Paper No. 27. 203pp + annexes 68pp.
- Kamanjab Bouvereeniging (2001). **Elephant Problems in the Kamanjab Area**. Letter from the Chairman of the Kamanjab Farmers' Association (Dr. H.J. Sartorius Bach) to the Permanent Secretary, Ministry of Environment and Tourism, 2 April 2001 requesting the Ministry to come up with viable solutions to the problem. 3pp
- Kilian W. (2004). **Mortality data for Etosha Elephant**. Records from the Etosha Ecological Institute, Ministry of Environment and Tourism, Namibia.
- Laws R.M., I.S.C. Parker & R.C.B. Johnstone (1975). **Elephants and their habitats: the ecology of elephants in North Bunyoro, Uganda**. Clarendon Press, Oxford.
- Lindeque, M. (1988). **Population dynamics of elephants in Etosha National Park, SWA/Namibia**. PhD thesis, Univ. Stellenbosch
- Martin R.B. (1993). **Should Wildlife Pay Its Way ?** Keith Roby Memorial Address. Murdoch University, Western Australia, December 1993.
- Martin R.B. (1999). **Commercial uses of wildlife, control systems and sustainability**. Paper presented at the Second International Wildlife Management Congress, 28 June - 2 July 1999, Gödöllő, Hungary. 44pp



- Martin R.B. (2004a). **Species Report and Management Plan for Elephants**. Project conducted under *The Transboundary Mammal Project* of the Ministry of Environment and Tourism, Namibia and facilitated by The Namibia Nature Foundation. 104pp
- Martin, R.B. (2004b). **Elephants and People**. PowerPoint Presentation for global distribution on Namibian elephant policy. Ministry of Environment and Tourism, Namibia, August 2004.
- Martin R.B. (2006). **Savé Valley Conservancy: Management of the Elephant Population**. Consultancy for the members of the Savé Valley Conservancy, funded by the US Fish and Wildlife Service. 73pp
- Martin R.B. (2007). **Ecological and socio-economic costs and benefits of alternative elephant conservation approaches**. Presentation in the Symposium *Sharing the range: Elephants, people and biological conservation in Africa* at the 21<sup>st</sup> Annual Meeting of the Society for Conservation Biology titled *One World, One Conservation, One Partnership* held at the Nelson Mandela Metropole in Port Elizabeth, South Africa, July 2007.
- Martin, R.B. (2008a). **Elephant trophy hunting I: use of a classic control system to set hunting quotas**. Paper prepared for *Ecological Modelling*, 35pp
- Martin R.B. (2008b). **Review of Safari Hunting in Botswana: Financial and Economic Assessment**. Consultancy for The Botswana Wildlife Management Association, June 2008. 40pp
- Martin R.B. (2009). **Background Study and Management Plan for Black Rhino**. Consultancy for the Ministry of Environment and Tourism, Namibia funded by WWF LIFE programme and ICEMA. Background Study 128pp, Management Plan 30pp, Supplementary Volume of Annexures 29pp.
- MET (2004). **Additional perspectives on Namibia's proposal to CITES COP 13 to amend the annotation regarding the Namibian population of *Loxodonta africana***. Supplementary document submitted to the CITES Parties at the 13th Conference of the Parties in Bangkok, Thailand, November 2004. 5pp
- MET (2009). **National Policy on Human-Wildlife Conflict Management**. Directorate of Parks and Wildlife Management, Windhoek. 34pp
- Murombedzi J. & M. Gomera (2004). **Towards a new tenure policy to accompany the land reform program in Zimbabwe**. Policy Brief, IUCN – World Conservation Union, Regional Office for Southern Africa, Harare.
- NACSO (2008). **Namibia's communal conservancies: a review of progress and challenges in 2007**. Publication Manager: John Mendelsohn, Design: Patricia Lynch-Blom, Published by the Namibian Association of CBNRM Support Organisations, Windhoek. 120pp
- NRMPS (2009). **Managing Namibia's Rangelands**. National Rangeland Management Policy and Strategy. Draft 1, November 2009. 44pp
- NAM (1990). **The Constitution of the Republic of Namibia**. 68pp
- OFU (1997). **Elephant infiltration Otjikondo District**. Letter from the Otjikondo Farmers' Union to the Director, Department of Environment & Tourism, 30 September 1997 reporting on a meeting of Otjikondo Farmers' Union which discussed the elephant problem. 2pp
- OFU (1999). **Proposals by the address the problem of elephant infiltration**. Document presented to a workshop convened at Grootberg by the Department of Nature Conservation in September 1999. 2pp
- Owen-Smith, Garth (1970). **The Kaokoveld: An Ecological Base for Future Development Planning**. Report to the SWA government written at the conclusion of his period as Agricultural Officer for the Kaokoveld Territory 1968-1970. 67pp + maps and photographs

- Parker I.S.C. (1984). **Rainfall, Geology, Elephants and Men.** In the *Extinction Alternative: Proceedings of an International Symposium*, Endangered Wildlife Trust, Johannesburg: 137-177
- Parker I.S.C & A.D. Graham (1989). **Men, elephants and competition.** Symp. Zool. Soc. Lond. 61:241-252
- Scholes R.J. & K.G. Mennell (Eds.)(2008). **Elephant Management: A scientific assessment for South Africa.** Wits University Press, Johannesburg. 619pp
- Scoones, Ian [Ed.](1994). **Living with Uncertainty: New directions in pastoral development in Africa.** Intermediate Technology Publications, London. 210pp
- Slotow R, I. Whyte & Markus Hofmeyr (2008). **Lethal Management of Elephants.** In: *Elephant Management: A scientific assessment for South Africa.* Eds. Scholes R.J. & K.G. Mennell (2008): 370-405
- Smithers, Reay H.N. (1983). **The Mammals of the Southern African Subregion.** University of Pretoria, Pretoria, RSA. 736pp
- Sweet, Jim (1998). **A Rainfall Model for Estimating Carrying Capacity.** Northern Regions Livestock Development Project, Ministry of Agriculture, Water and Rural Development, Namibia. 4pp
- Viljoen P.J. 1982. **The Distribution and Population Status of the larger mammals in Kaokoland, South West Africa/Namibia.** *Cimbebasia (A)* 7: 5-33
- Viljoen P.J. 1987. **Status and past and present distribution of elephants in the Kaokoveld, South West Africa/Namibia.** *S. Afr. J. Zool.* 1987, 22(4): 247-257
- Viljoen P.J. 1988. **The ecology of the desert-dwelling elephants *Loxodonta africana* (Blumenbach 1797) of Western Damaraland and Kaokoland.** PhD Thesis, University of Pretoria.
-